

*Sels oscillatrices.
 sous les noyaux
 sont rouges | 650Ω
 800Ω*

*Sauf le Do qui est
 Blanc | 180Ω
 250Ω*

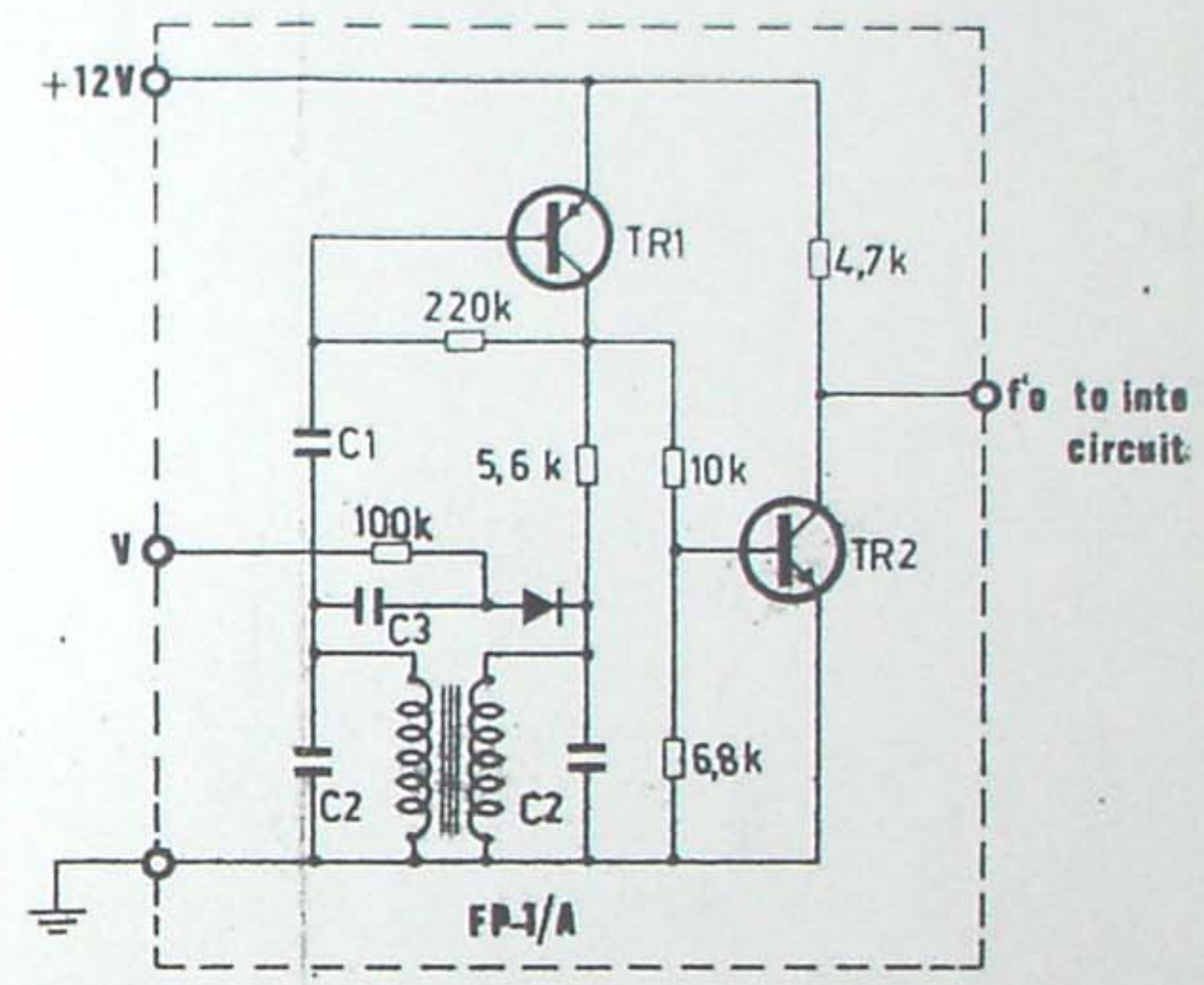
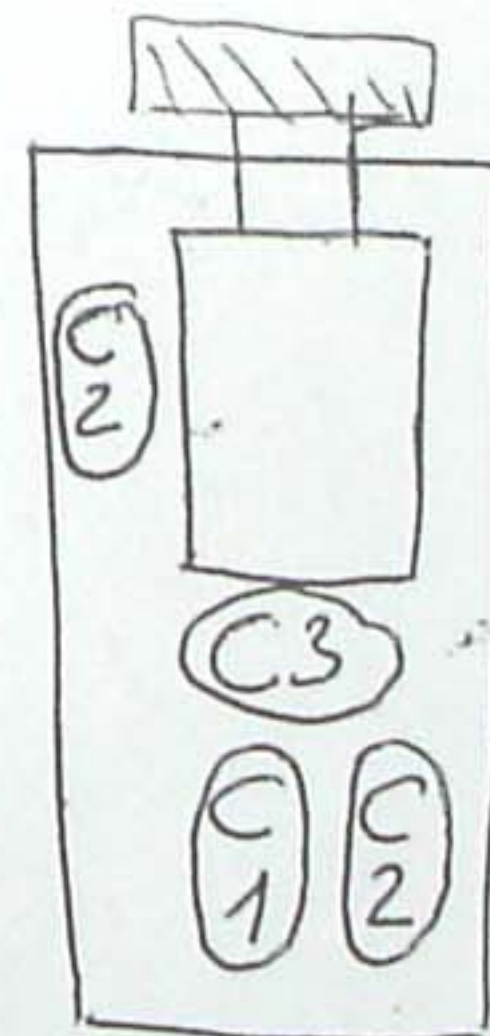
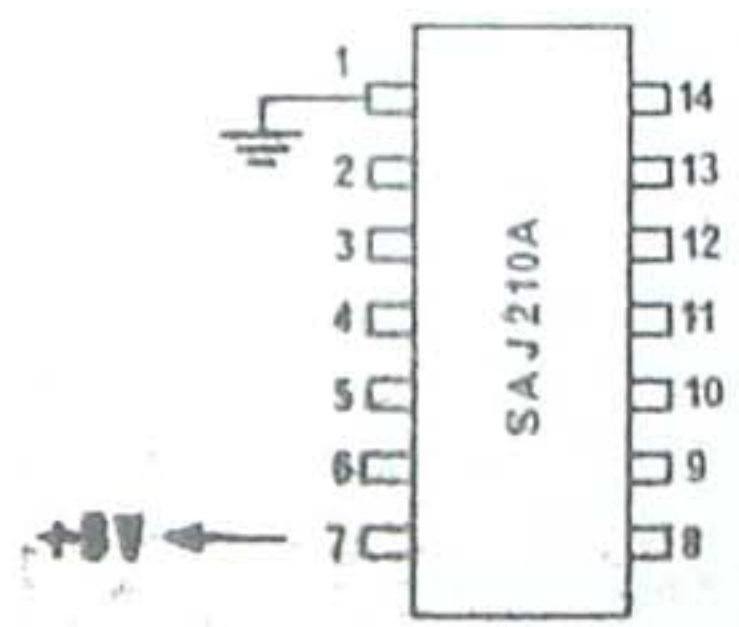

NOTE	FREQ.	C1 (mf)	C2 (mf)	C3 (mf)
DO ^b -C ^a	2218	6,0	15	4,7
RE-D	2349	6,0	15	4,7
RE ^b -D ^a	2488	5,6	12	3,9
MI-E	2636	5,6	12	3,9
FA-F	2794	5,6	12	3,9
FA ^b -F ^a	2960	4,7	8,2	3,3
SOL-G	3136	4,7	8,2	3,3
SOL ^b -G ^a	3322	4,7	8,2	3,3
LA-A	3520	3,3	6,8	2,7
LA ^b -A ^a	3729	3,3	6,8	2,7
SI-B	3951	3,3	6,8	2,7
DO-C	4186	3,3	12	4,7

CRUMAR s.p.a. Castelfidardo ITALIA		N°	DATE	MODIFICATION
MODEL	DATE			
STRINGMAN	20-5-74			
	SCALE			
DRAWN BY	DESIGNED BY	DRS. N°		
Neofatti Giovanni	Andriani Pietro			

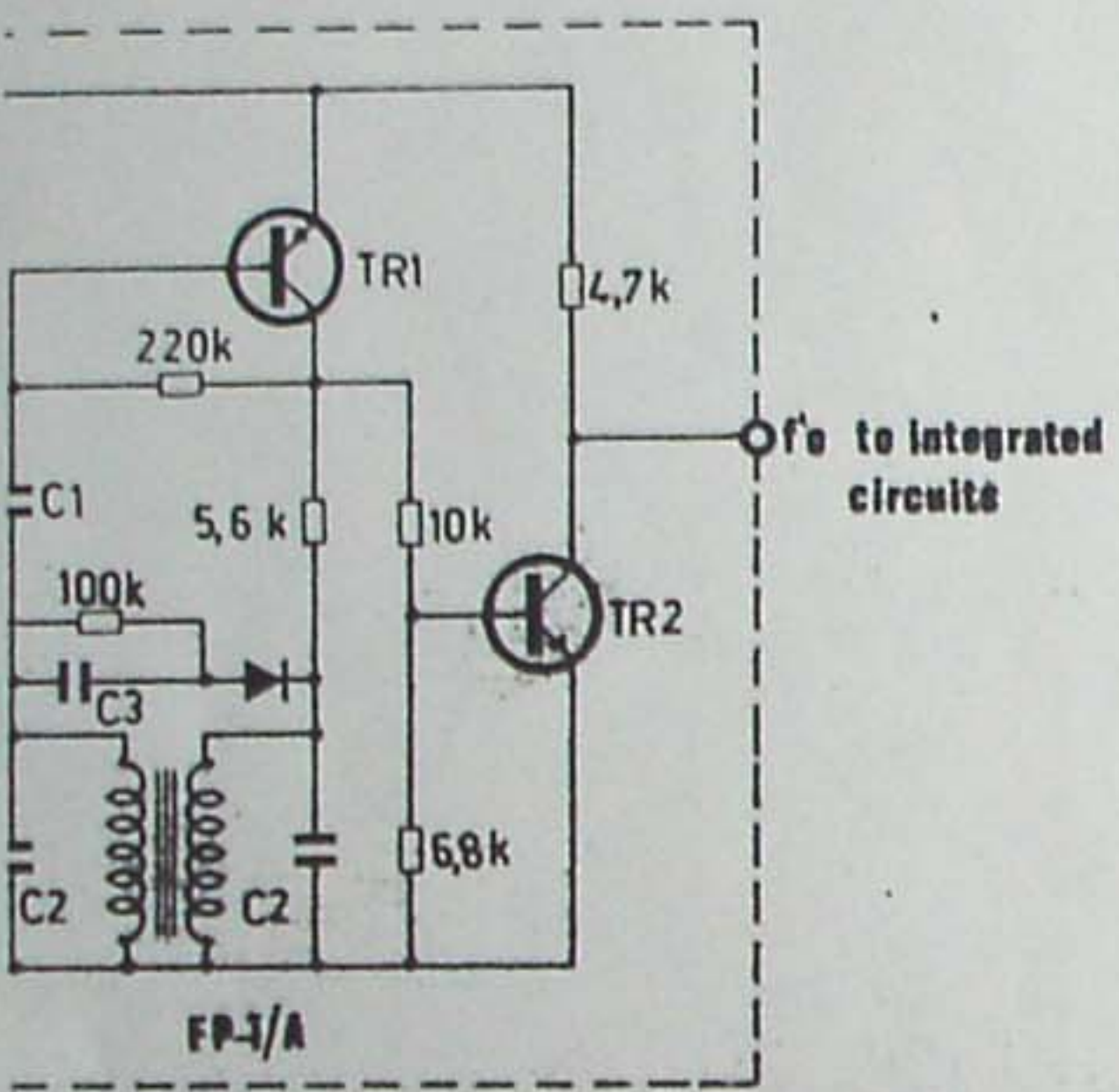

F	FREQ.	C1 (mf)	C2 (mf)	C3 (mf)
C*	2218	6.8	15	4.7
B	2348	6.8	15	4.7
B*	2488	5.6	12	3.9
E	2638	5.6	12	3.9
F	2794	5.6	12	3.9
F*	2960	4.7	8.2	3.3
B	3136	4.7	8.2	3.3
B*	3322	4.7	8.2	3.3
A	3520	3.3	6.8	2.7
A*	3729	3.3	6.8	2.7
B	3951	3.3	6.8	2.7
C	4186	3.3	12	4.7

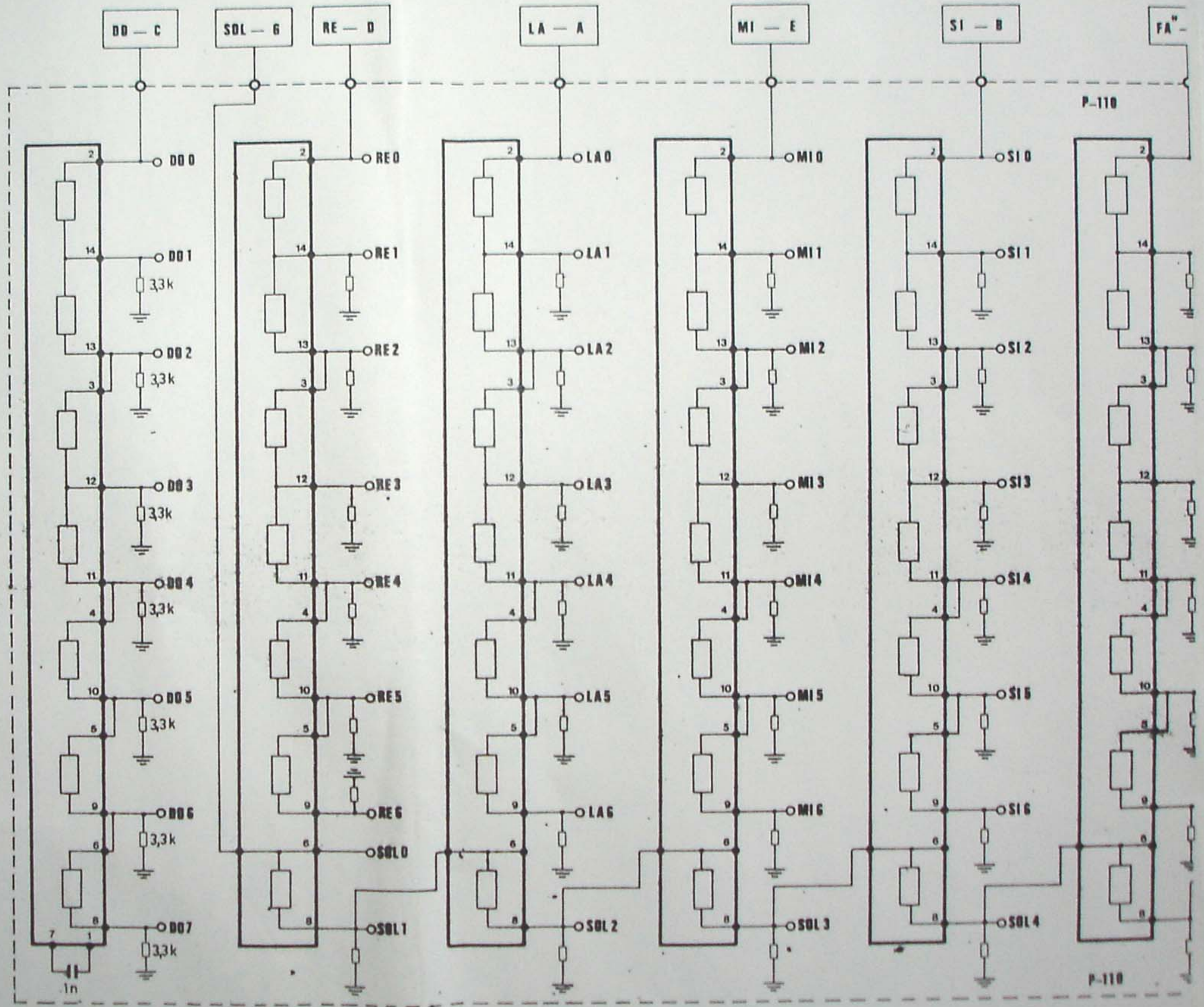

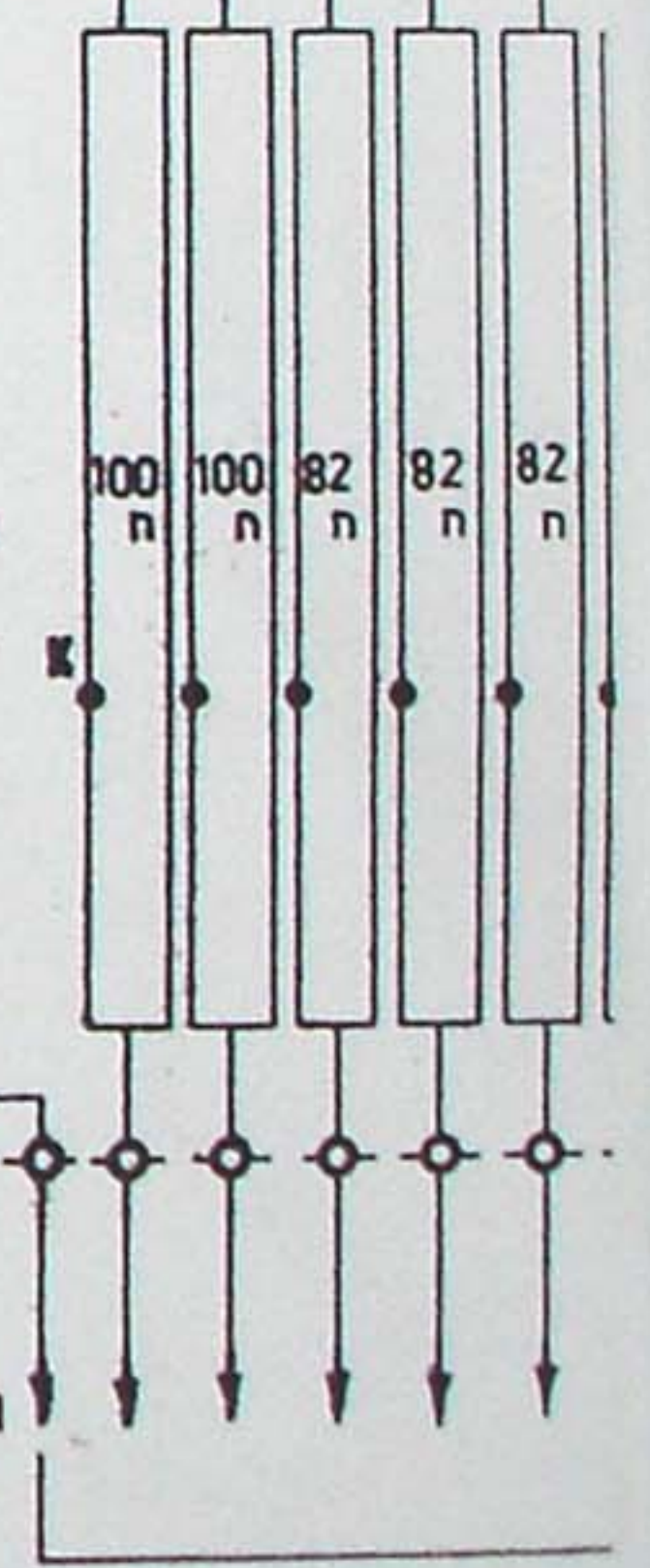
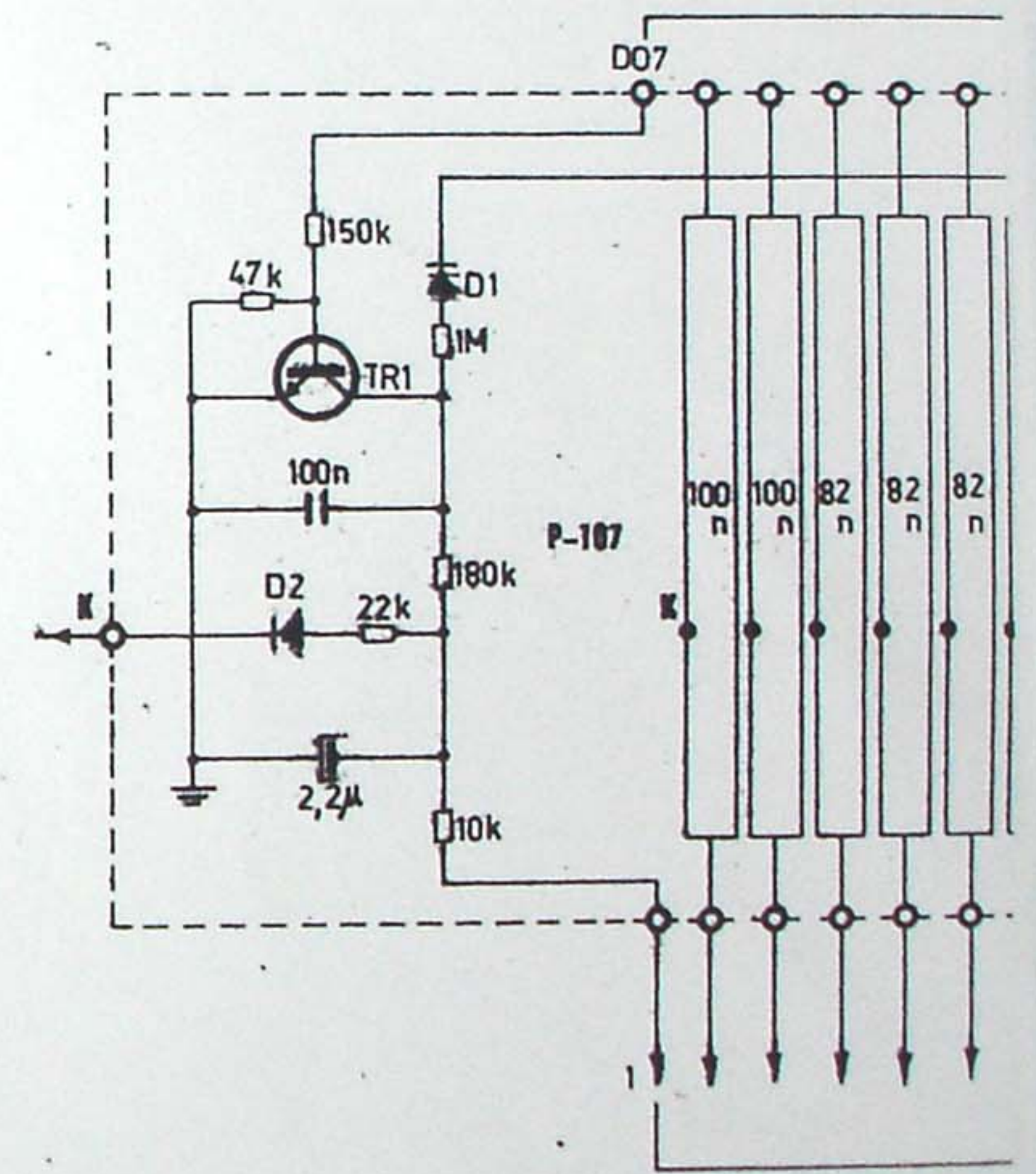
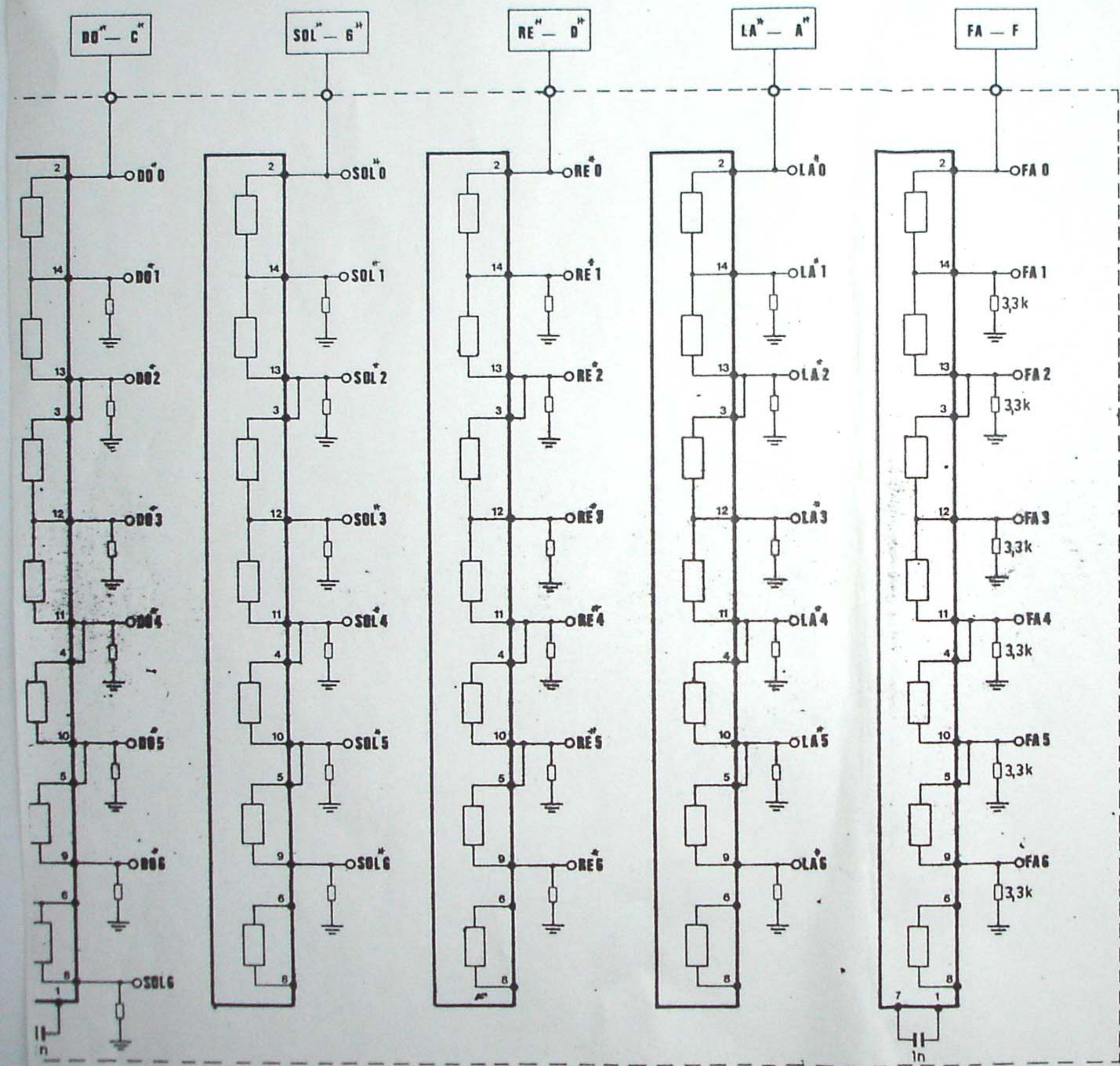

BASS GATES

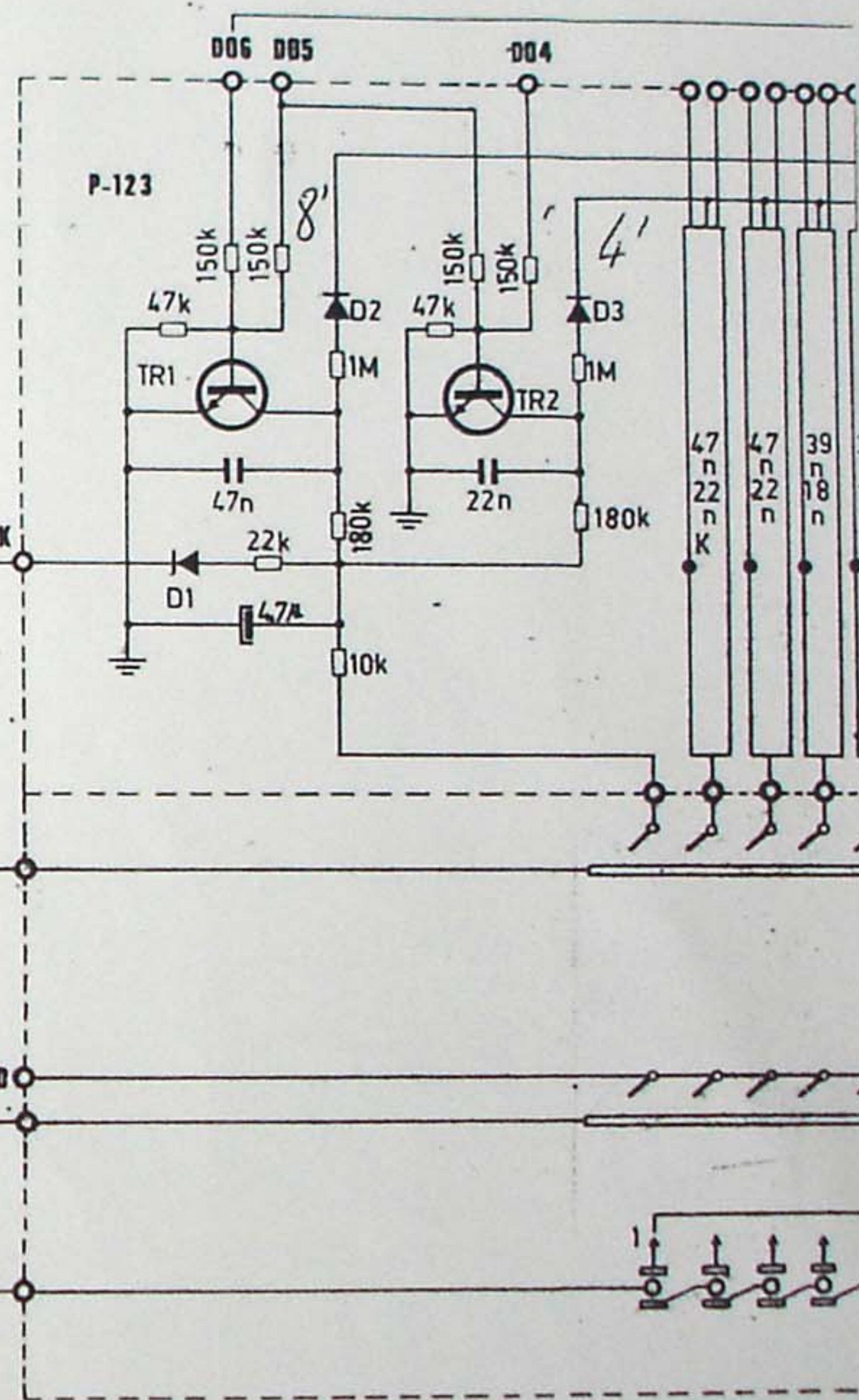
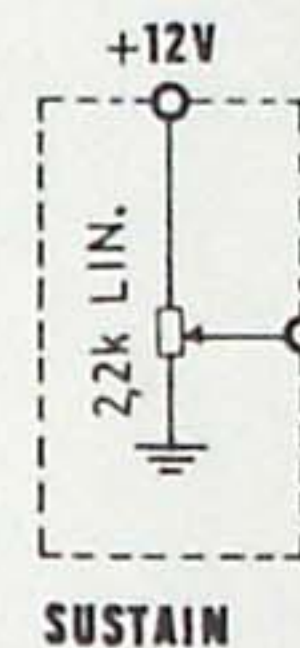
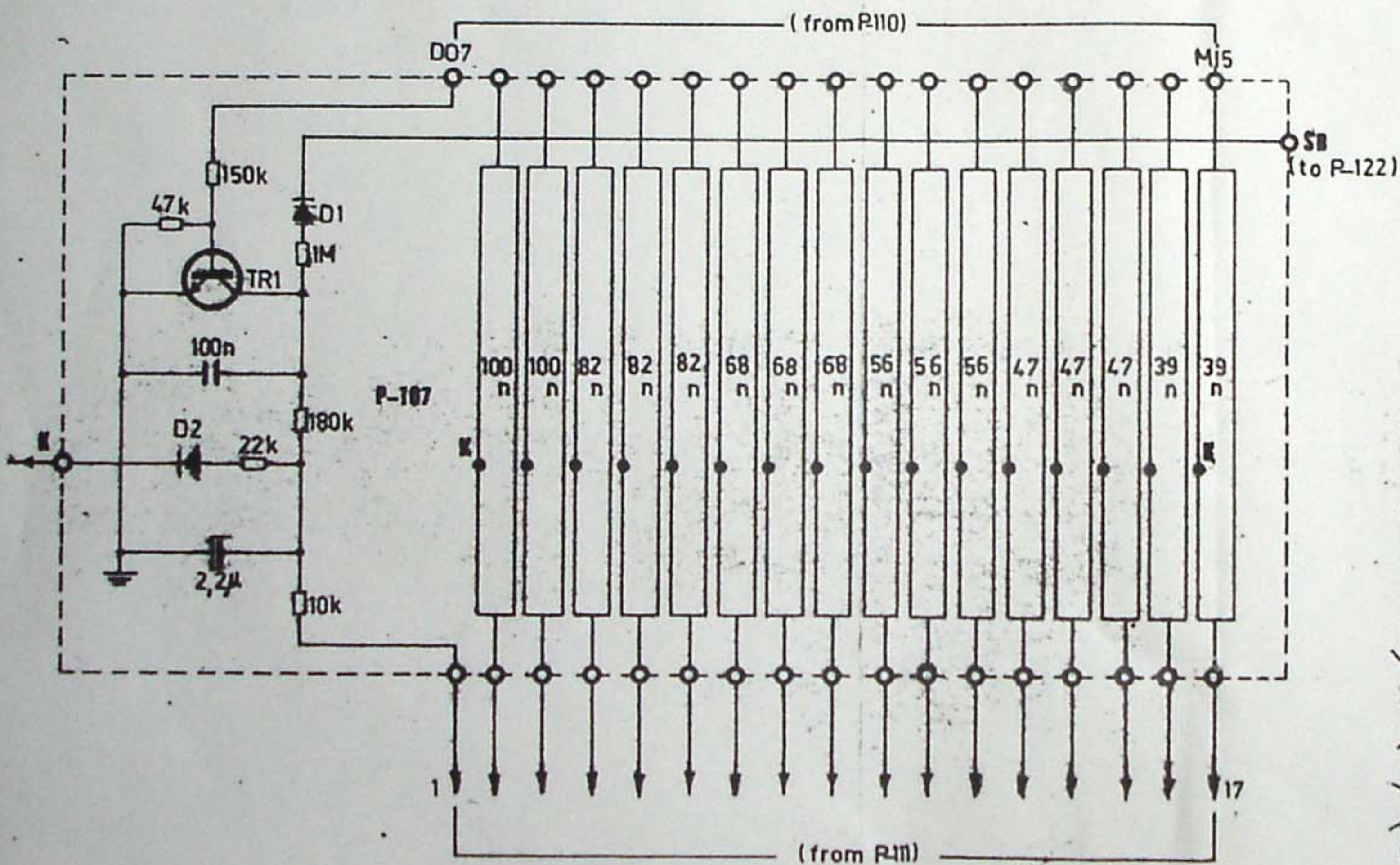

FMP55172
BC172

Cello 8' = Tr du haut.
Violin 4' = Tr du bas.

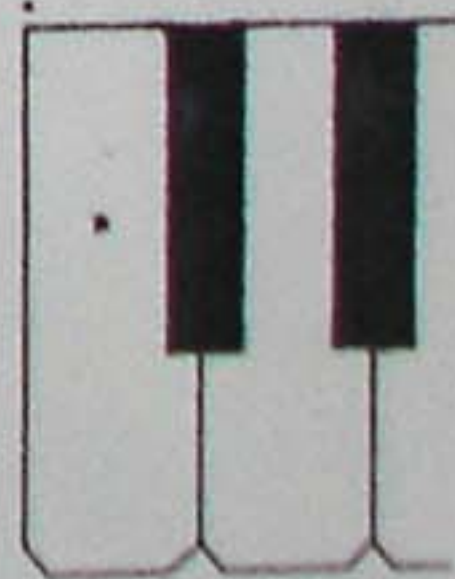

TREBLE GATES

(from P-110)

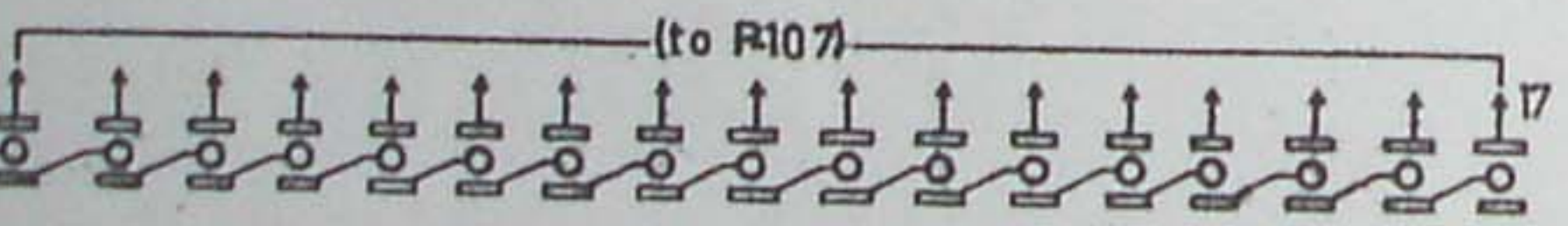
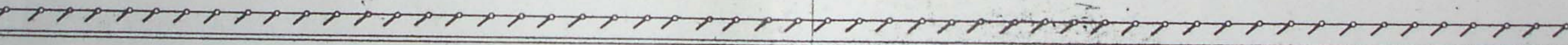
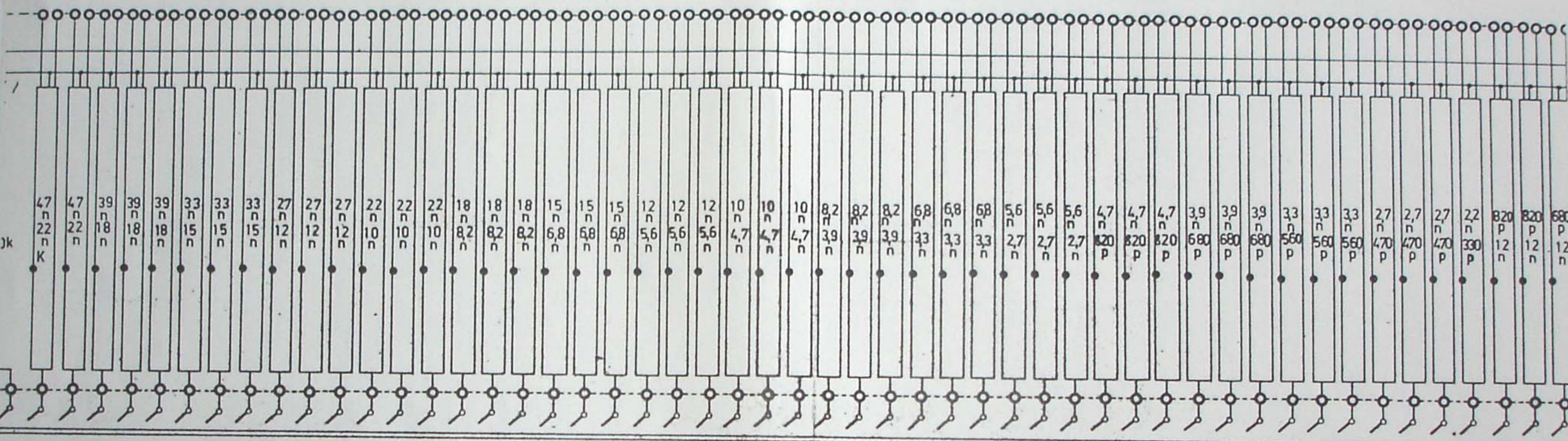

P-111

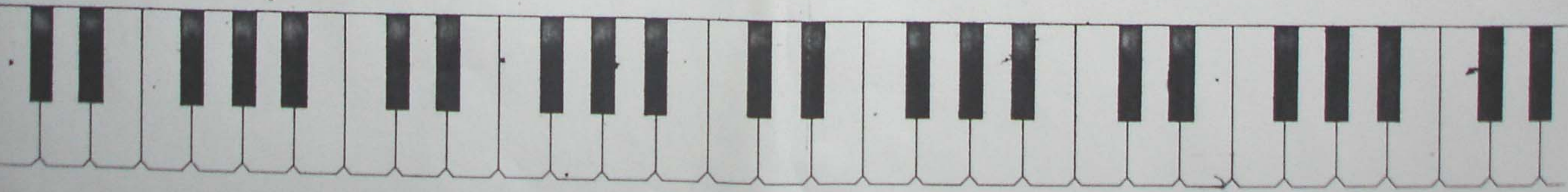

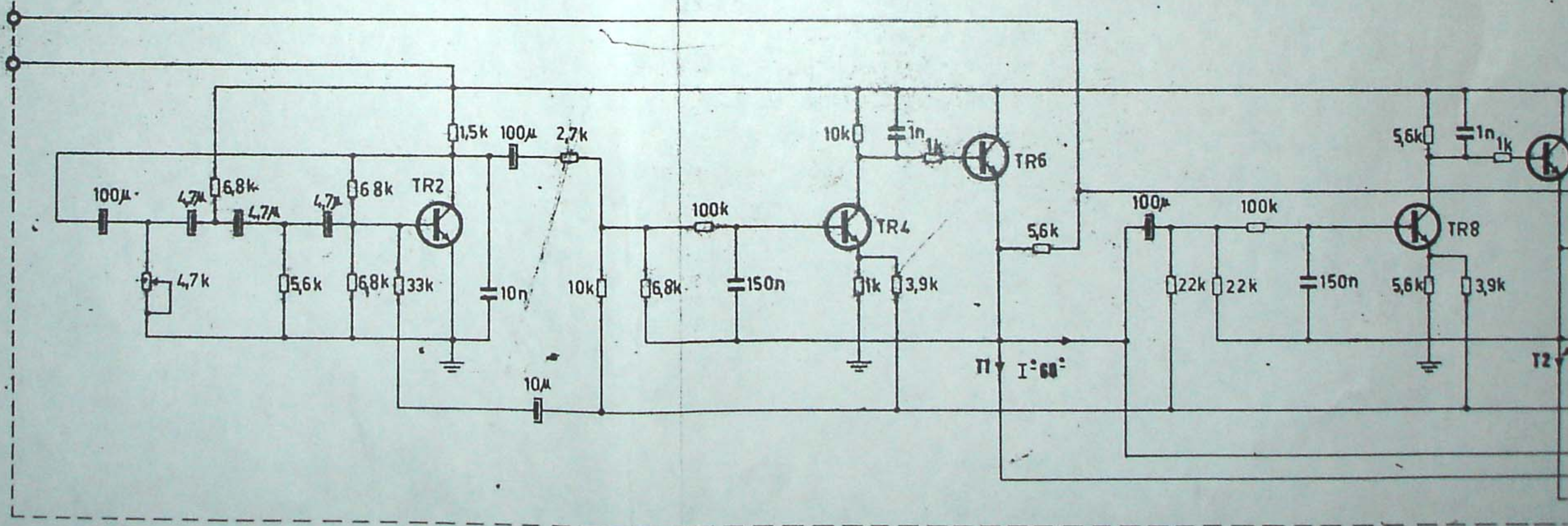
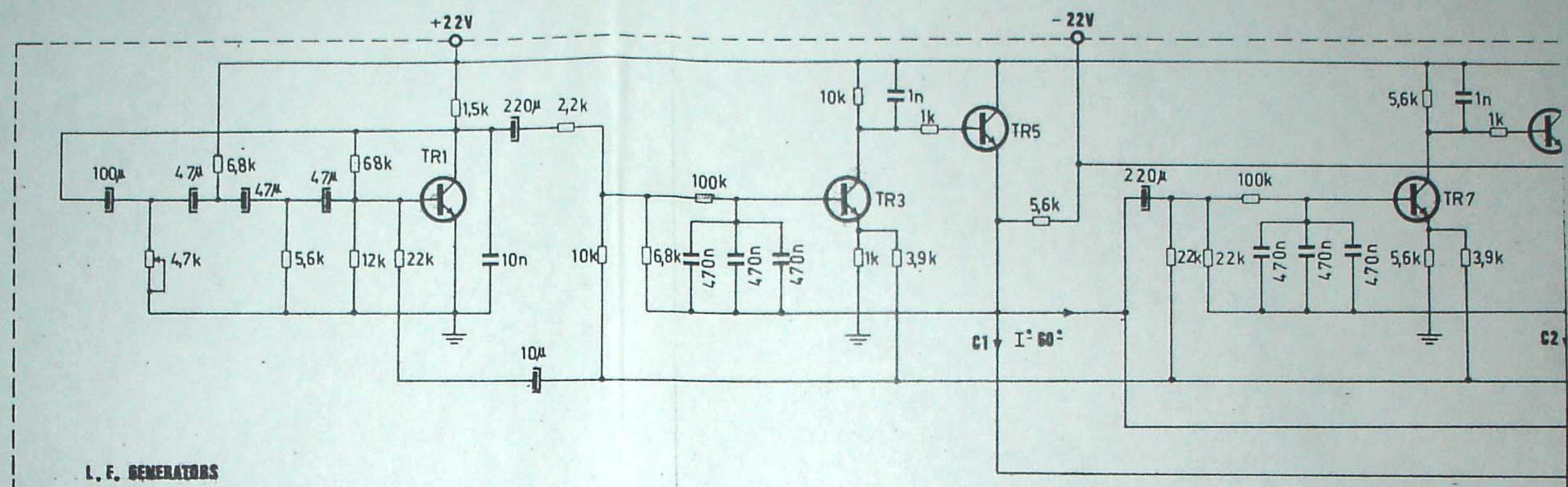
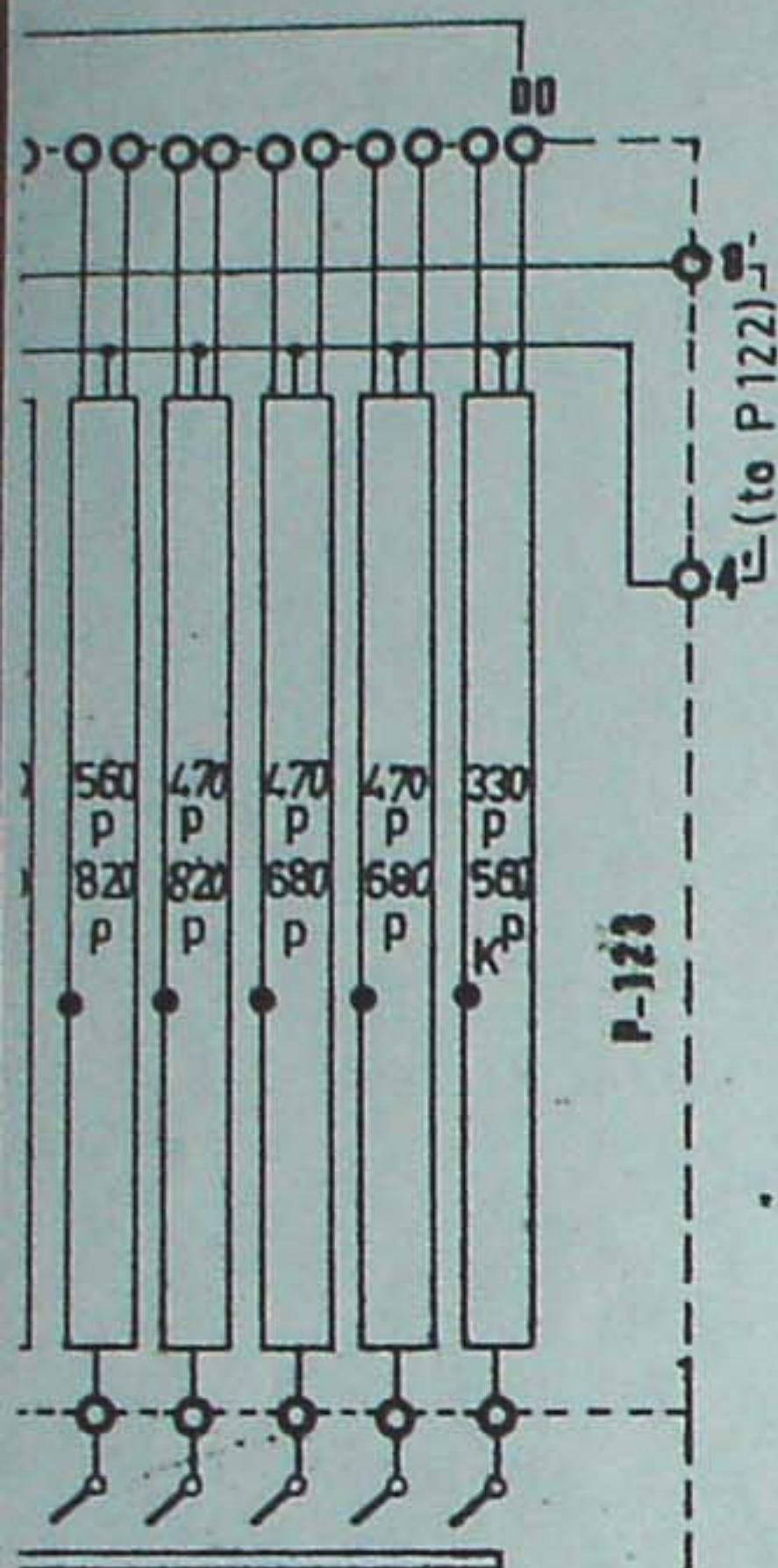

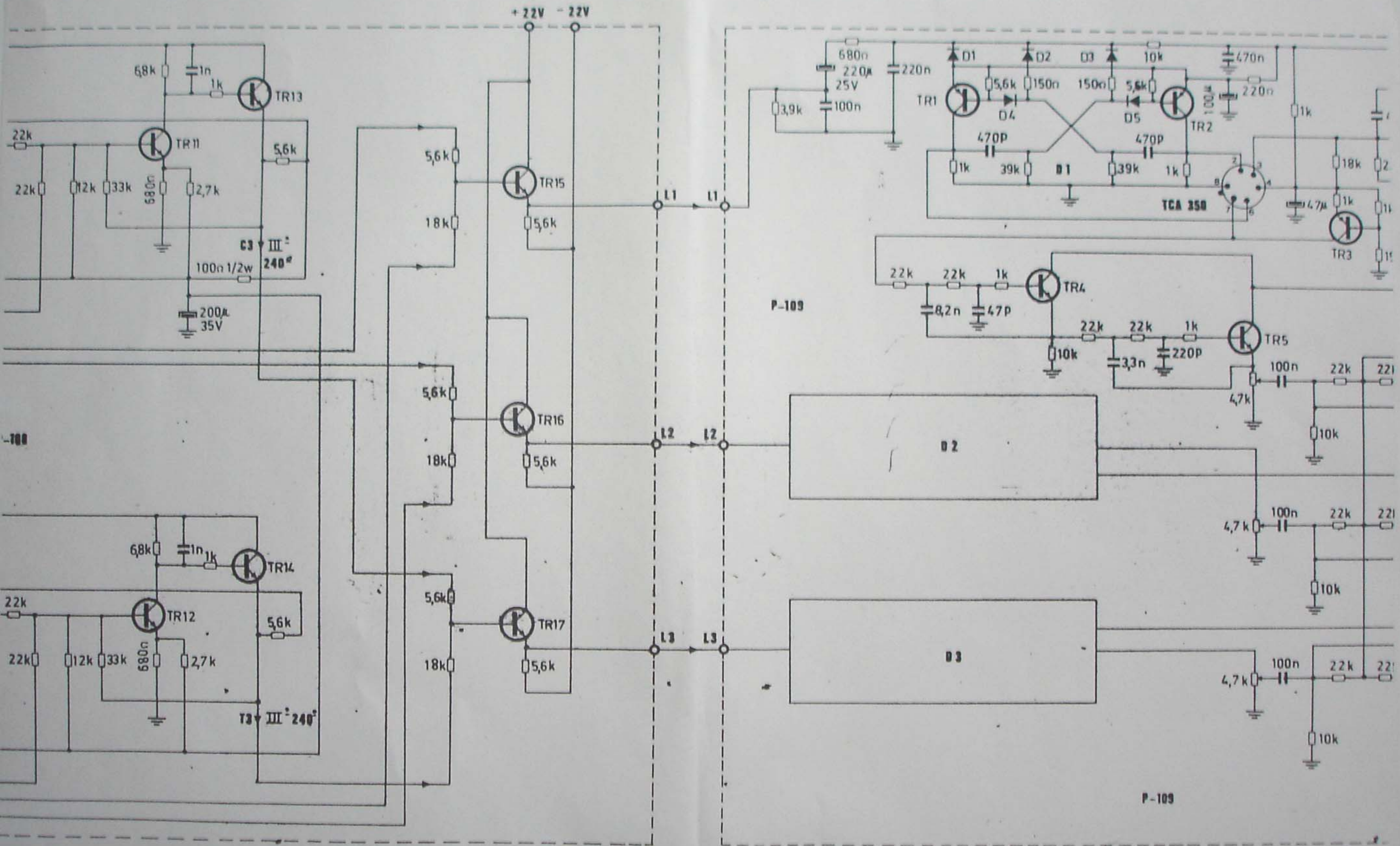

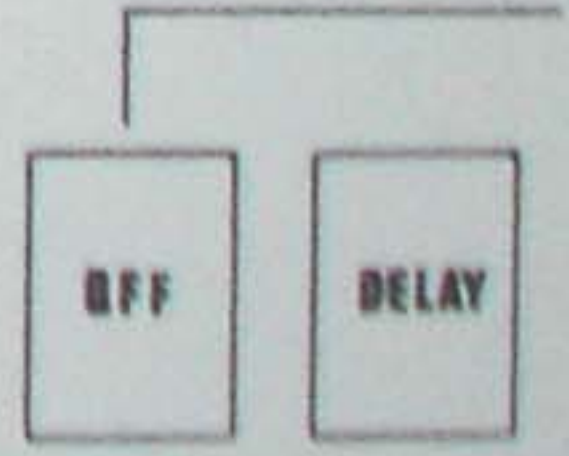
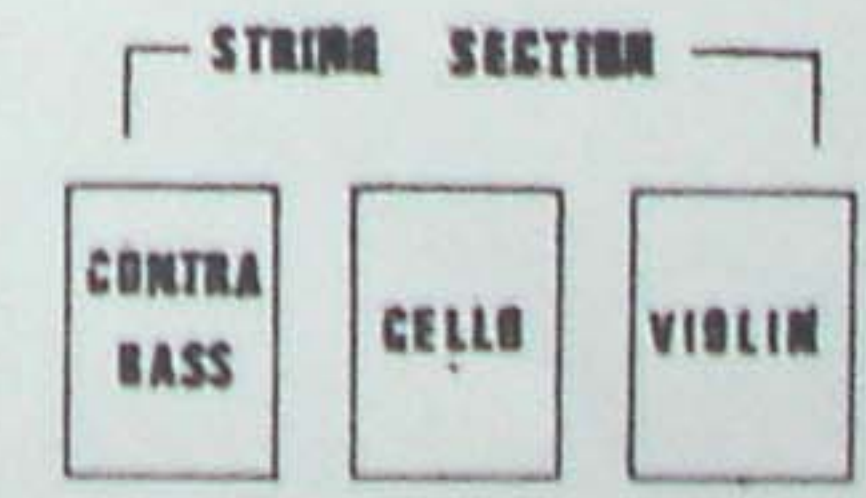
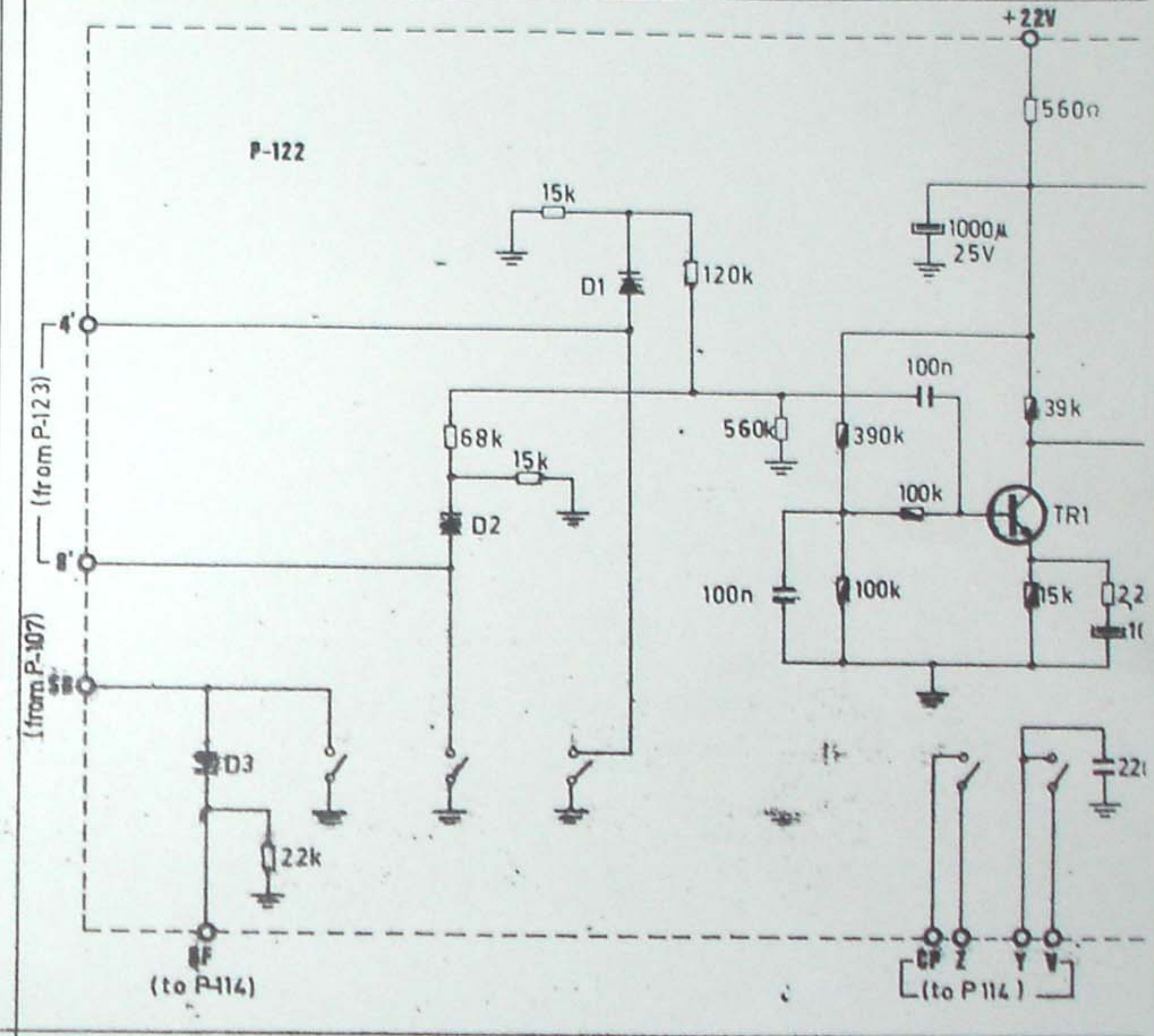
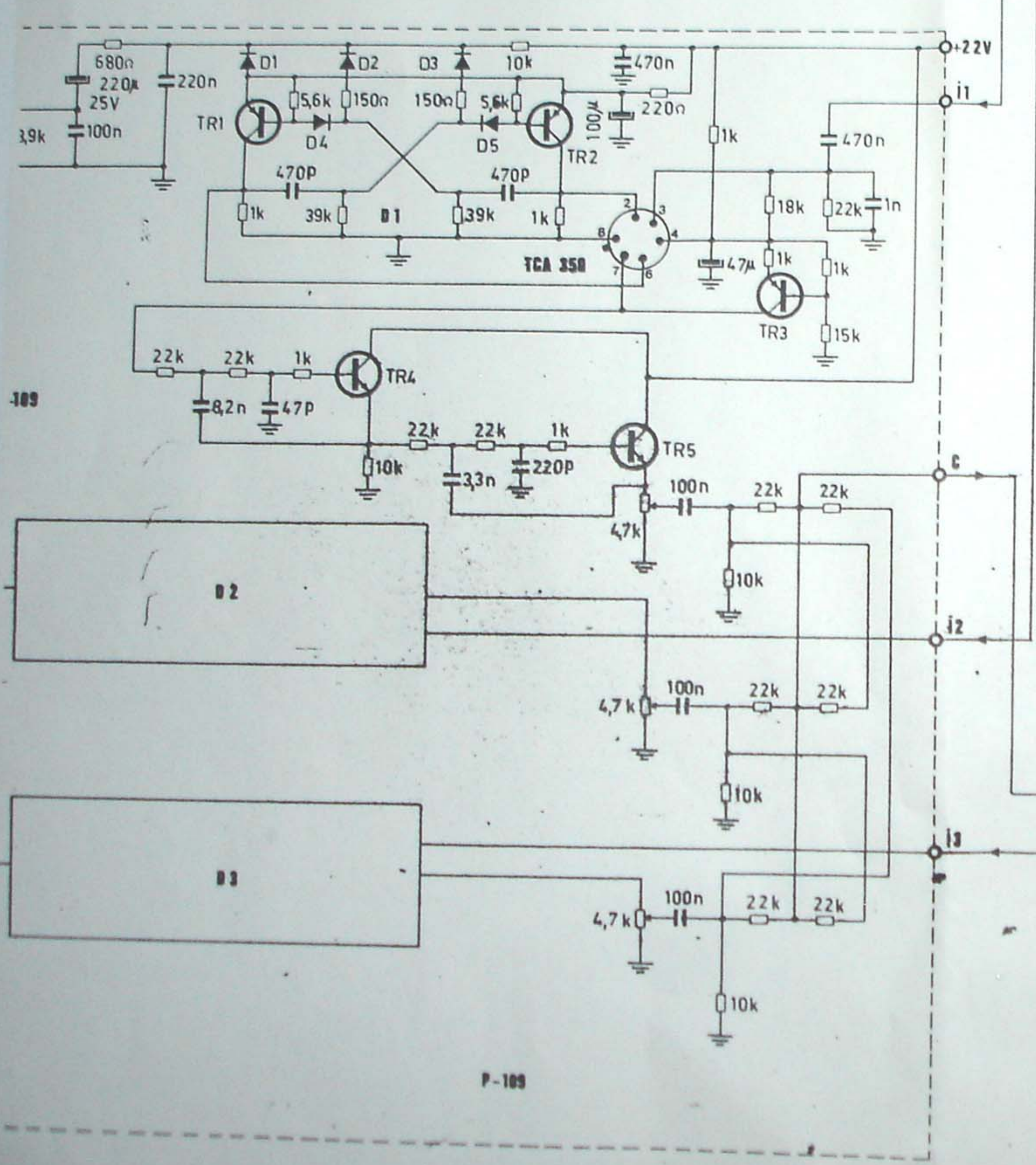

ON

VIBRATO

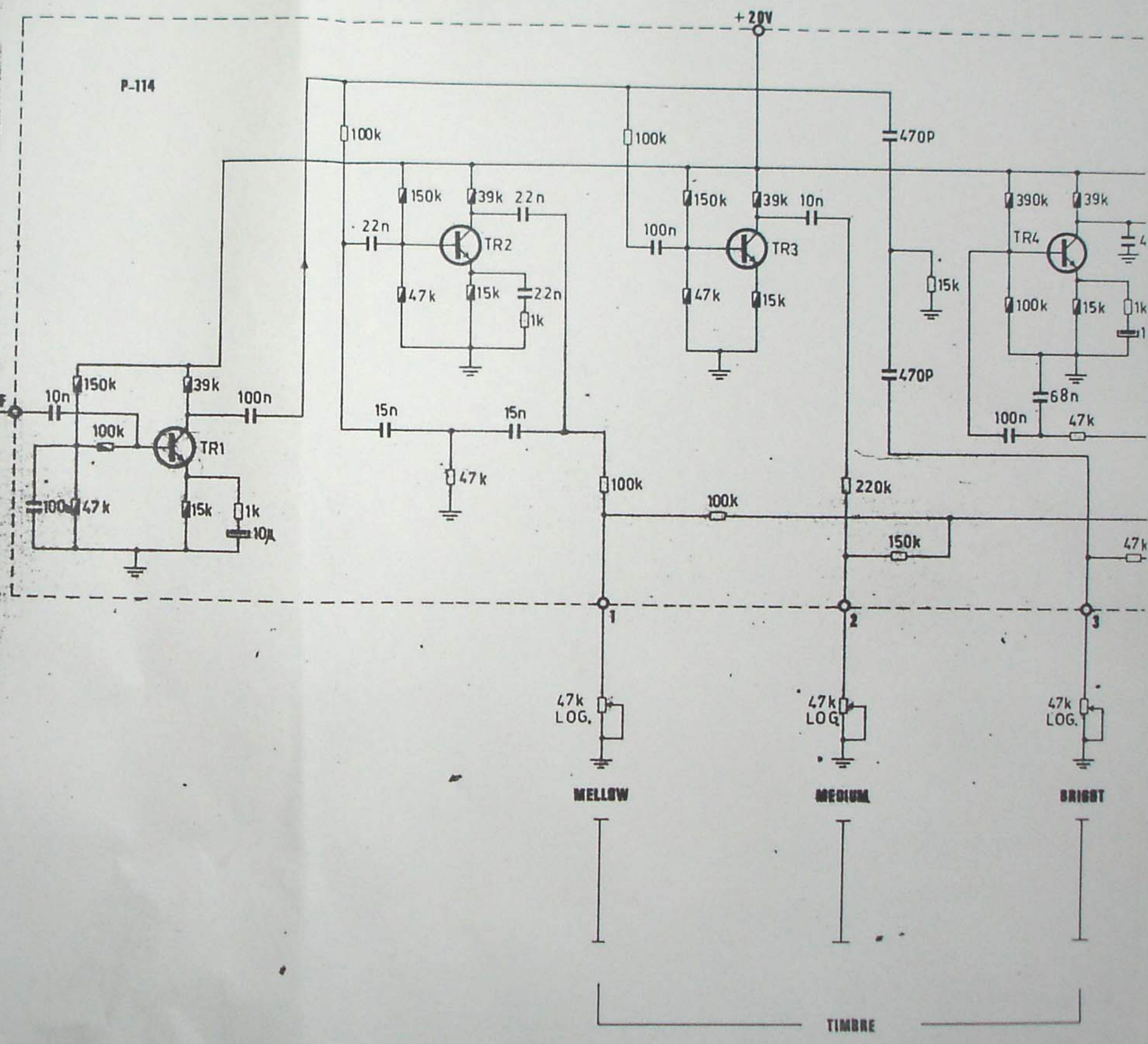
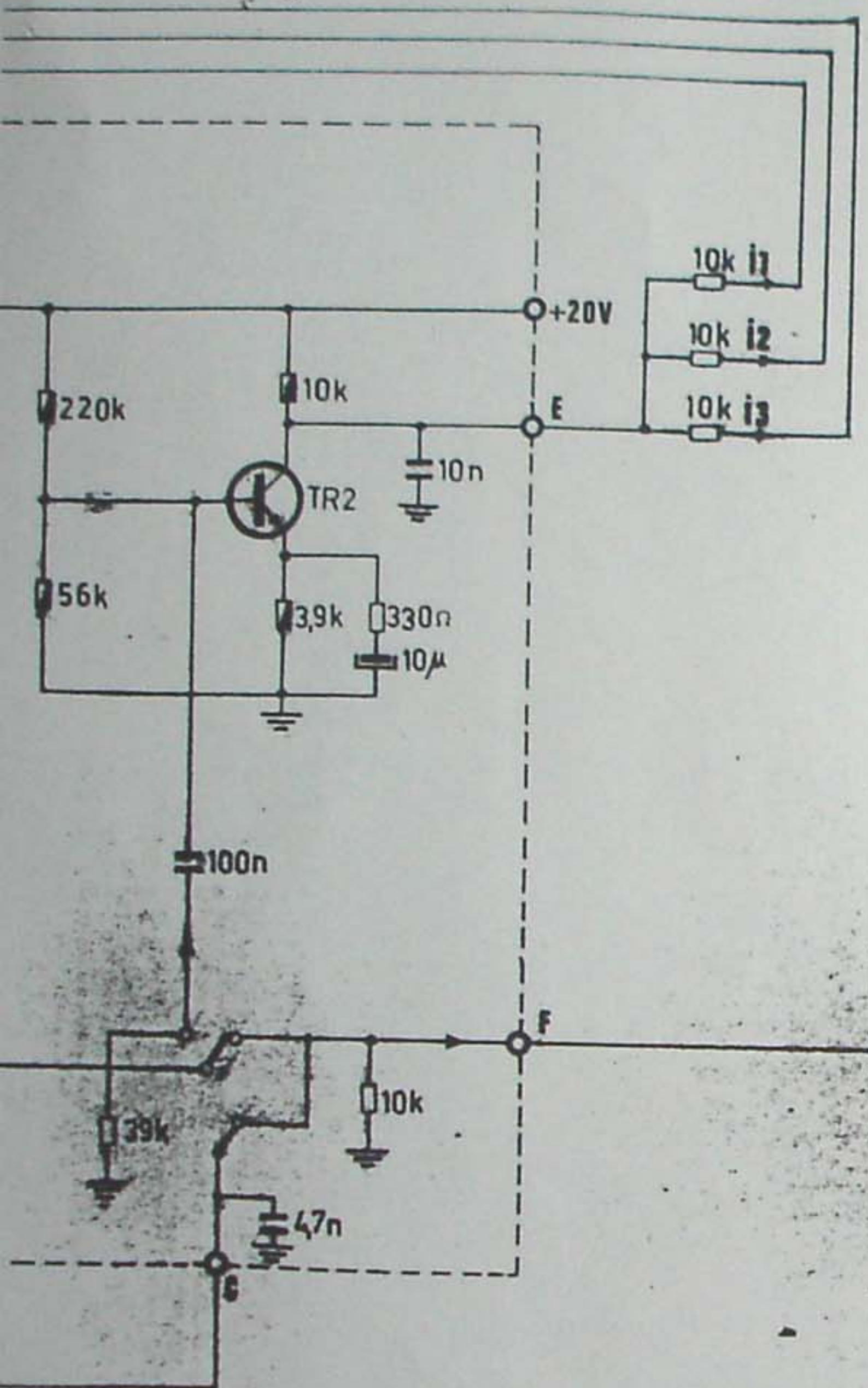

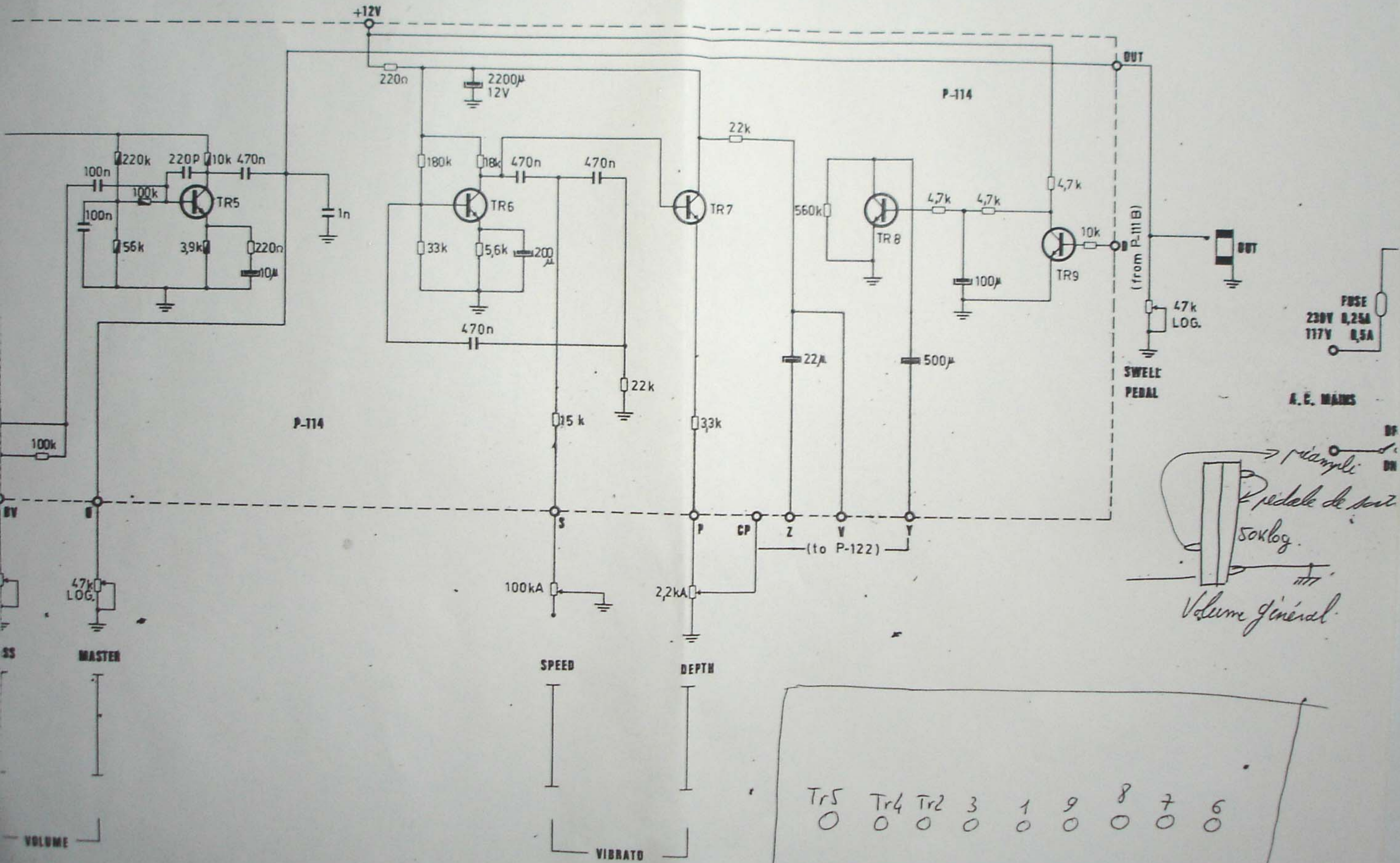

Tr5 Tr4 Tr2 3 1 9 8 7 6
 O O O O O O O O O

miamply
pedale de sonz
50klog.
Volume general.

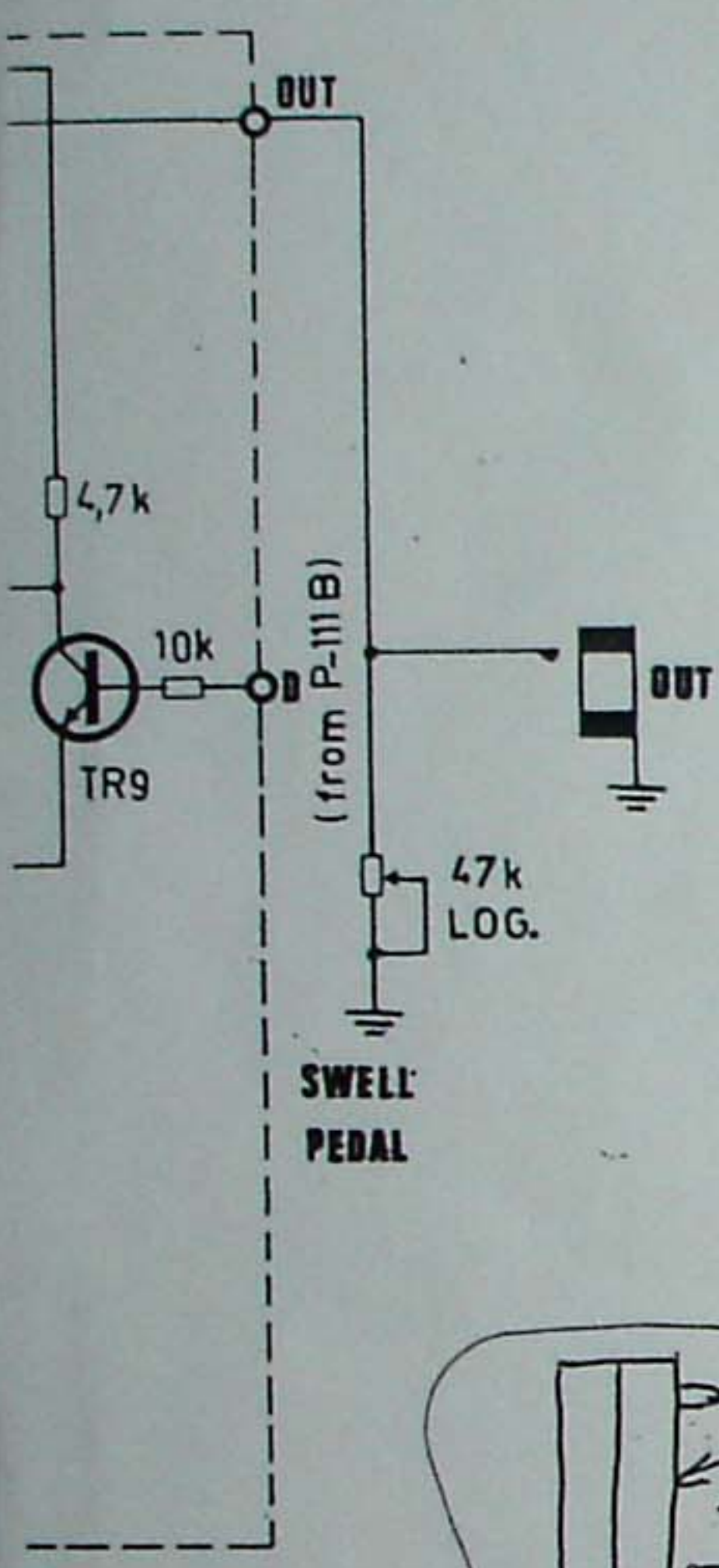

piampoli
pedale de sortie
50k log.
Volume général.

FUSE
 230V 0,25A
 117V 0,5A

A.C. MAINS

OFF
 ON

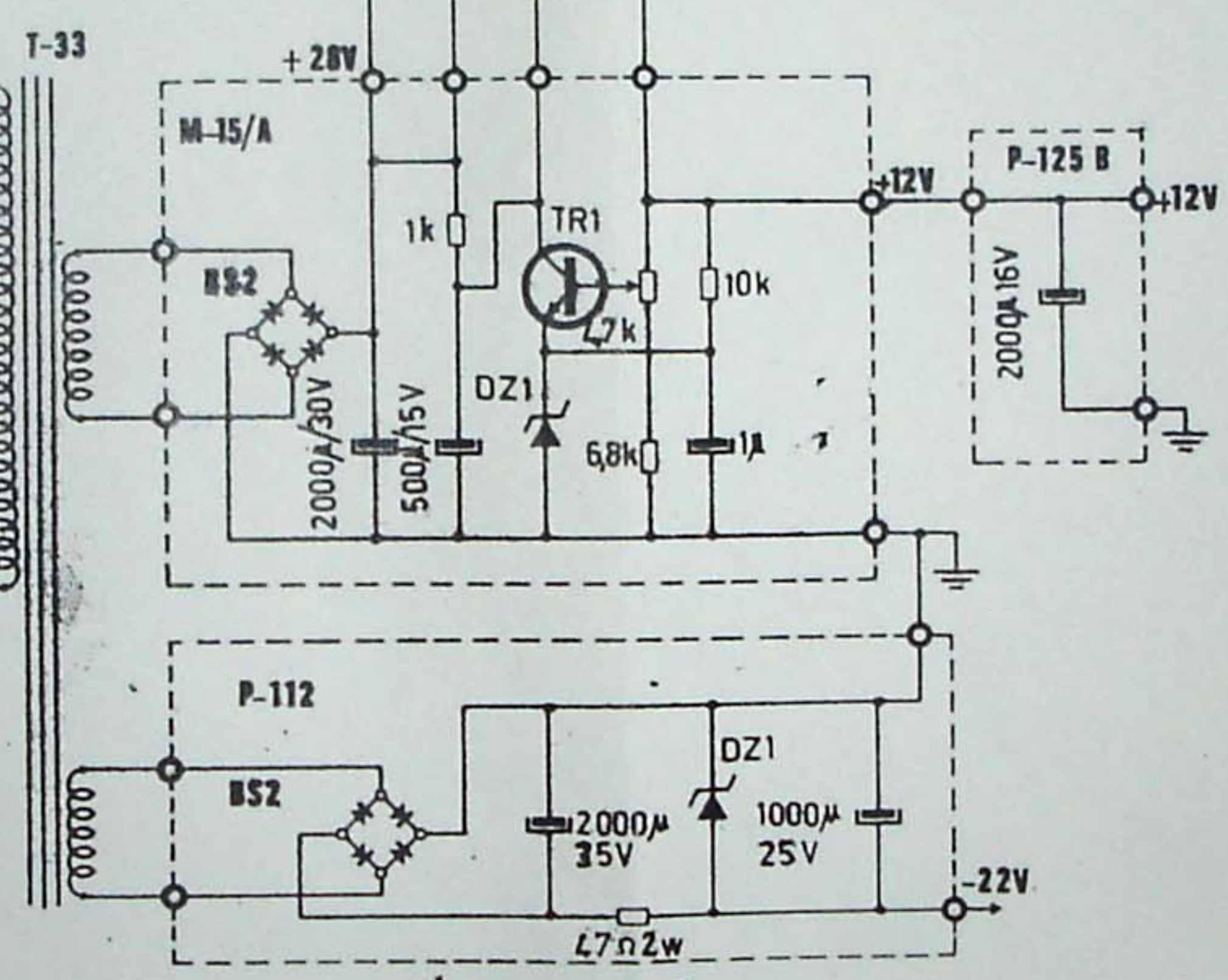
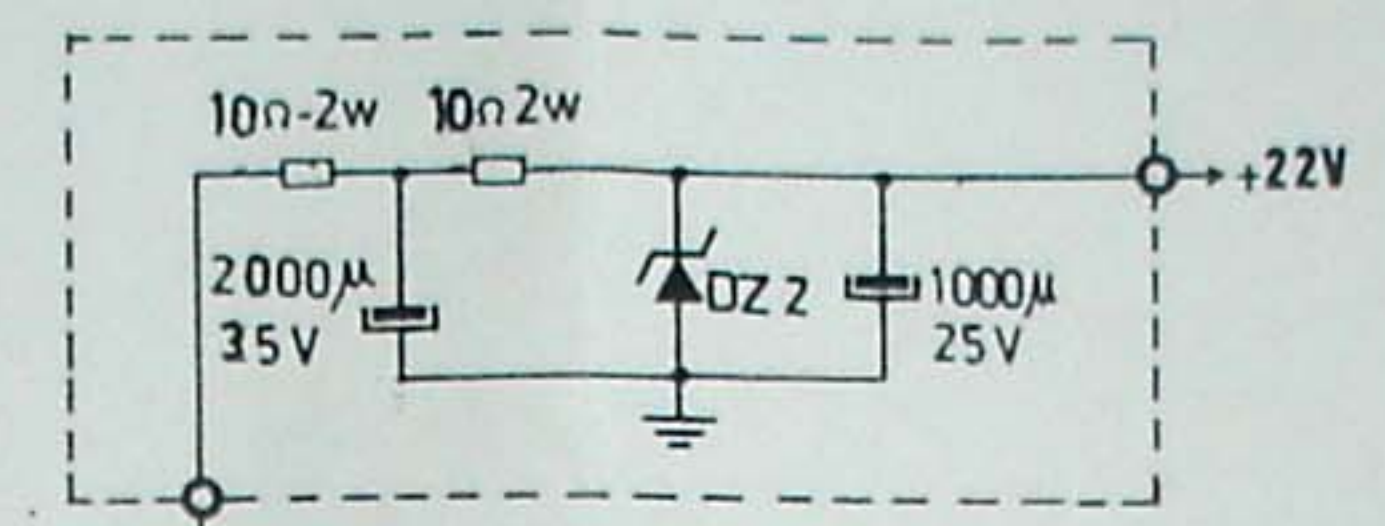

P-112

BS2

47n2w

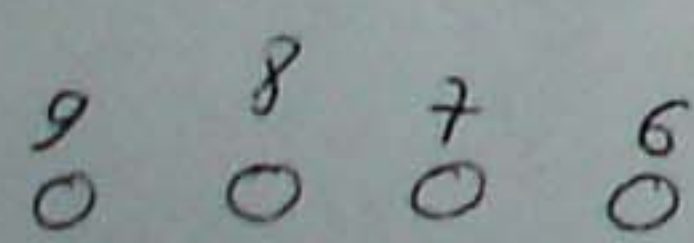

BOARD	REFERENCE	TYPE-N°
FP1/A	TR1	BC 204 MISTRAL
	TR2	SFT 714 MISTRAL
P-123	TR1 ÷ TR122	SFT 714 MISTRAL
	D1 ÷ D3	BA 130 S. G. S.
P-108	TR1 ÷ TR17	BC 109C PHILIPS
P-109	TR1 ÷ TR3	BC 204 MISTRAL
	TR4 ÷ TR5	BC 109 B PHILIPS
	D1 ÷ D5	FDN 900 FAIRCHILD
P-122	TR1 ÷ TR2	BC 109 B PHILIPS
	D1 ÷ D3	BA 130 S. G. S.
P-114	TR1 ÷ TR9	BC 109 B PHILIPS
P-112	DZ1 ÷ DZ2	ZY 22 I. R.
M 16/A	TR7	BC 115 S. G. S.
	TR2	2N3055 R.C. A.
	DZ1	1N960B I. R.
P-107	TR1 ÷ TR17	SFT 714 MISTRAL
	D1 ÷ D34	BA 130 S. G. S.