

L. bodart

jointolement de plaque en plâtre
jointolement des têtes de vis et de clous

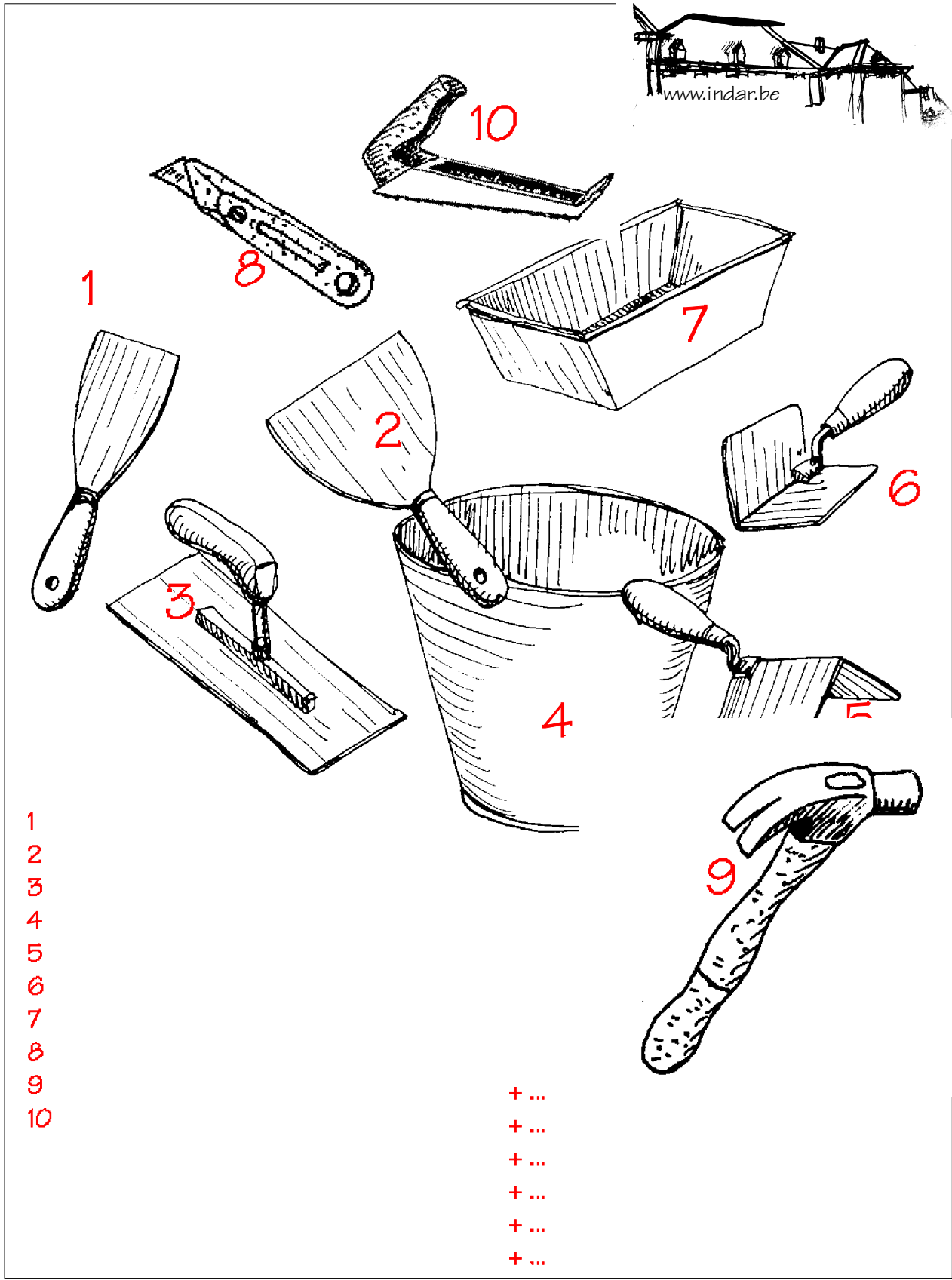

L. bodart

jointoiment de plaque en plâtre LES OUTILS

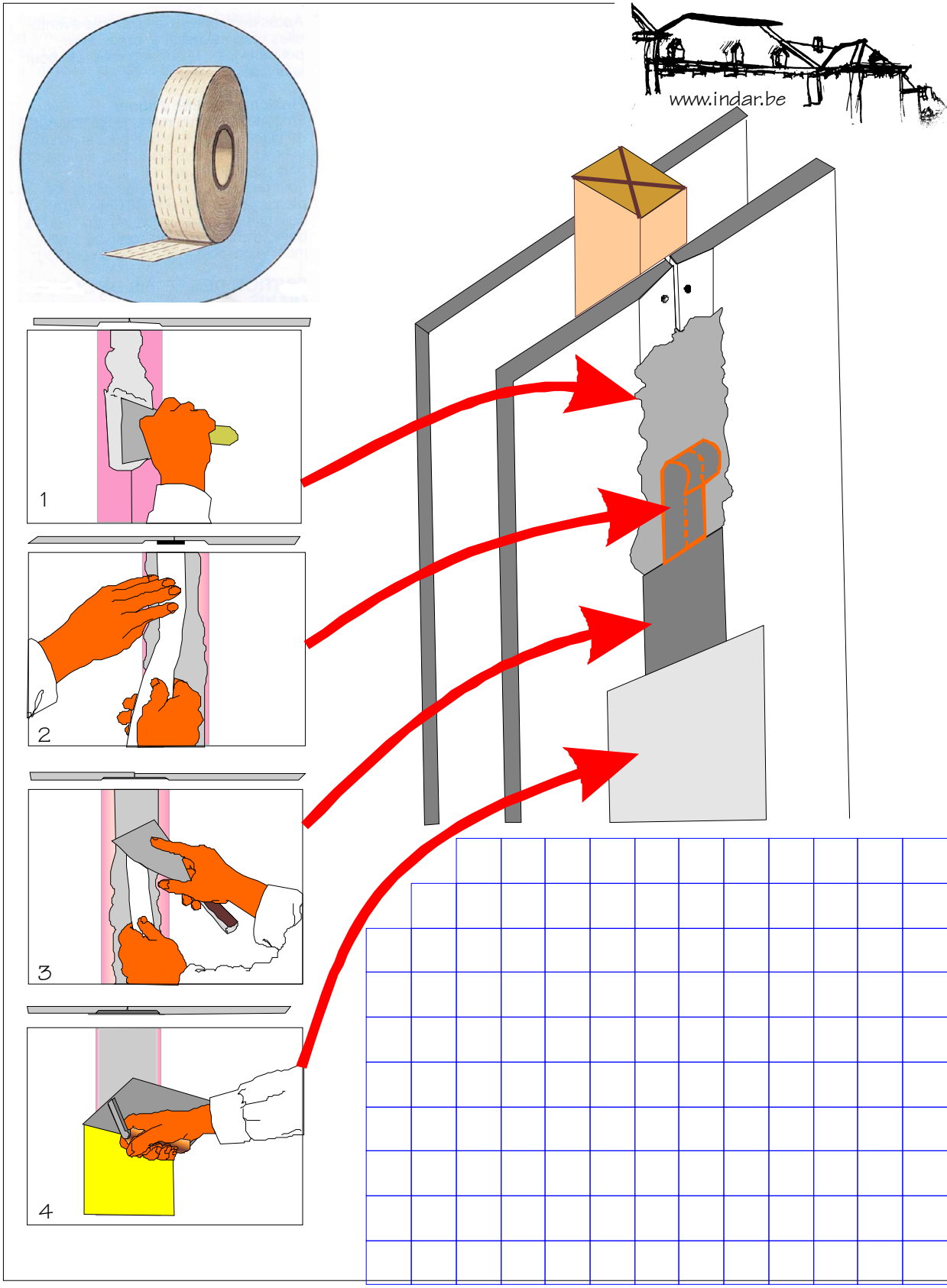

jointolement de plaque en plâtre à bords amincis
avec calicot en papier

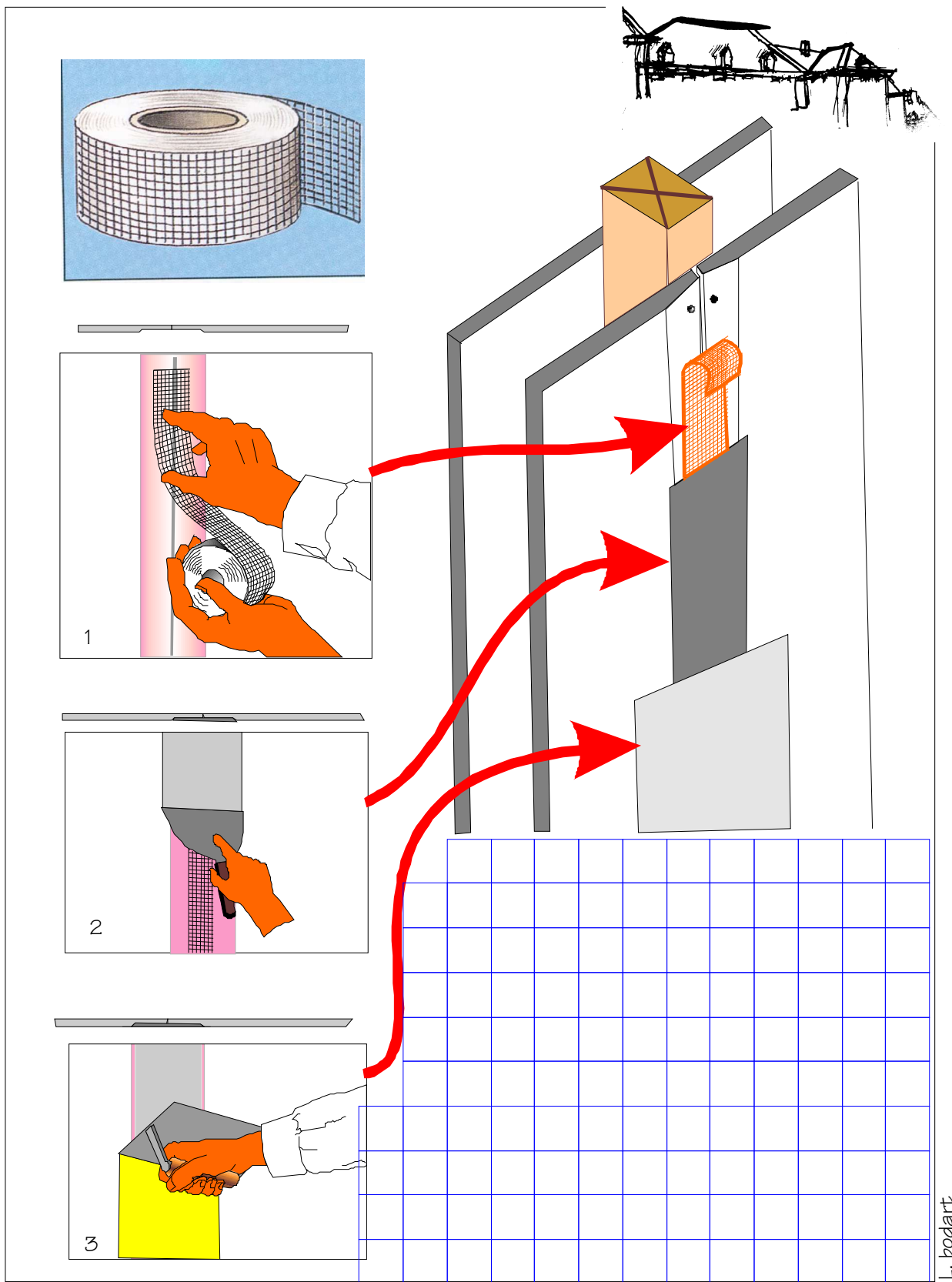

jointoiment de plaque en plâtre à bords amincis
avec une bande d'armature autocollante

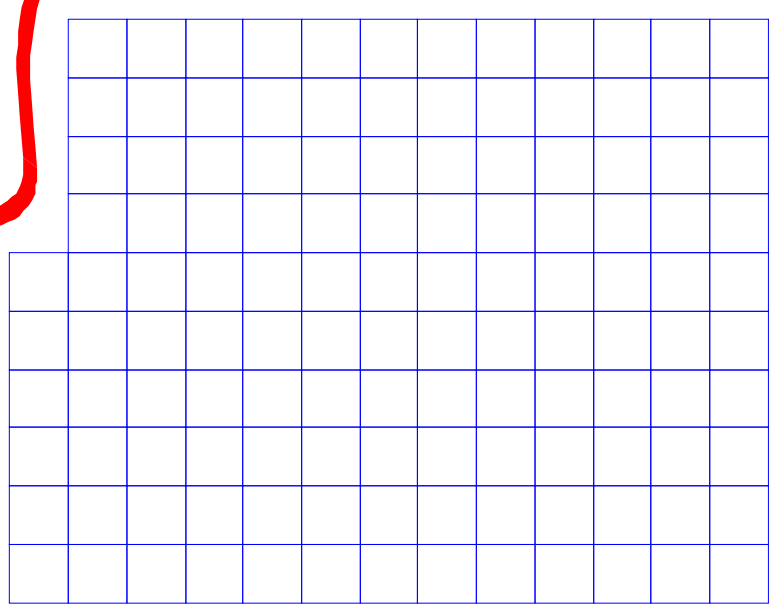
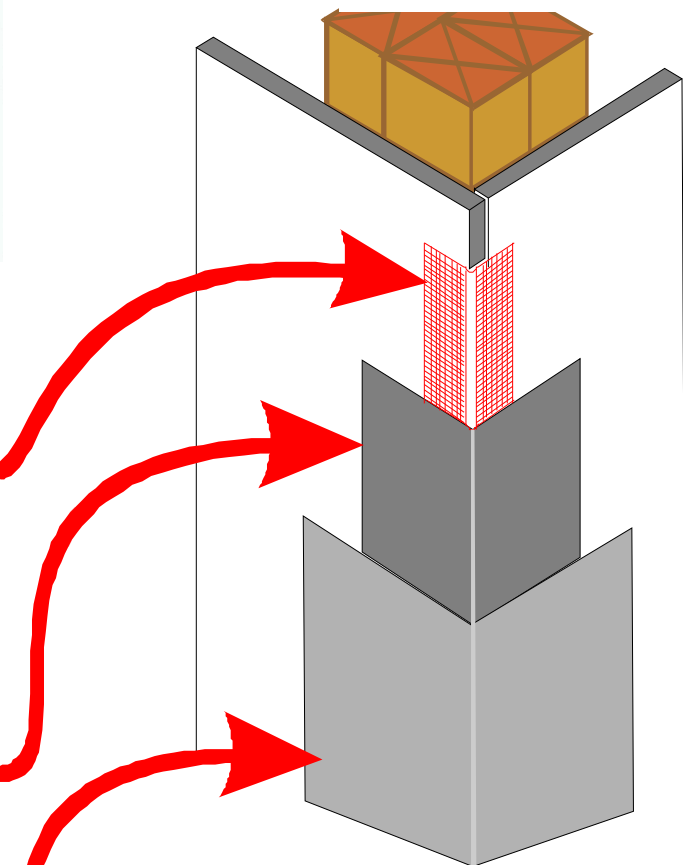
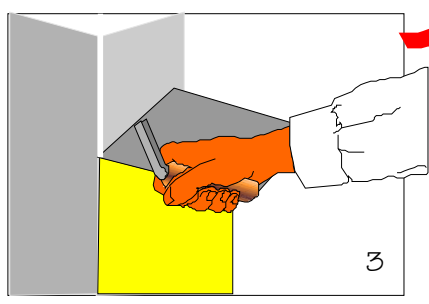
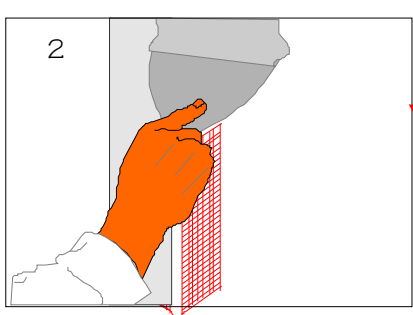
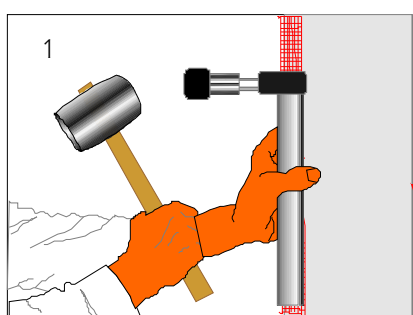
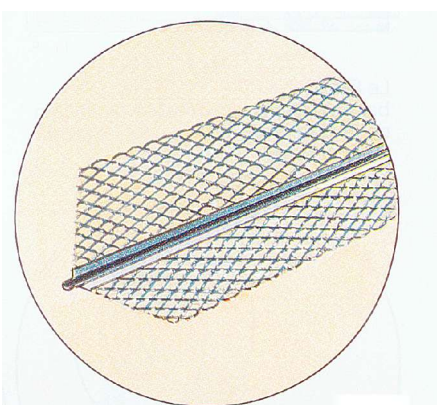

L. bodart

jointoiment d'angle sortant de plaque en plâtre avec un profilé métallique

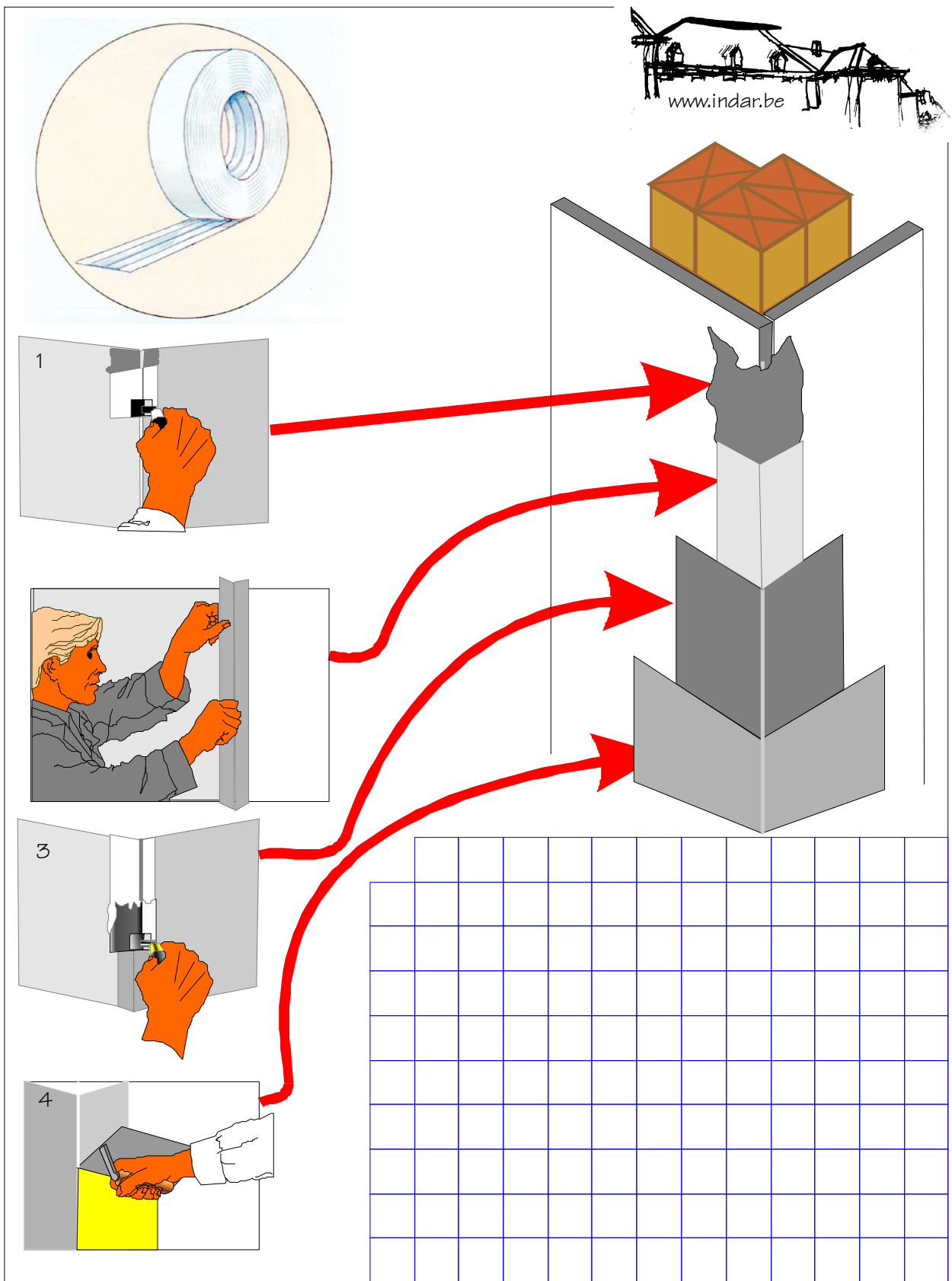

jointoiment d'angle sortant de plaque en plâtre
avec une bande de papier perforée renforcée de métal

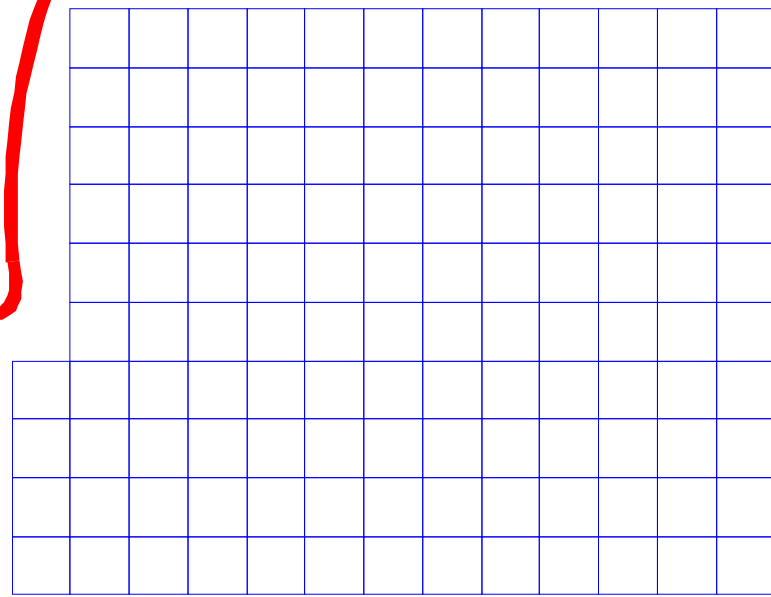
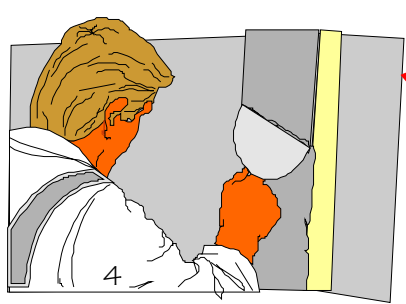
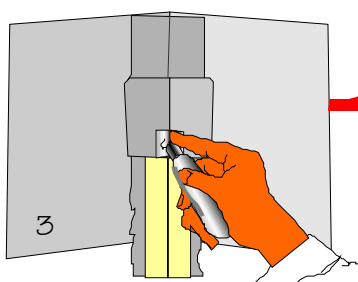
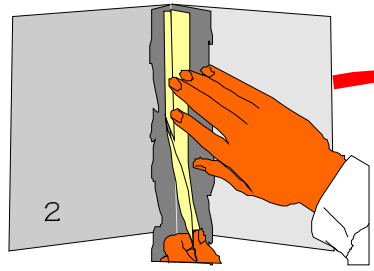
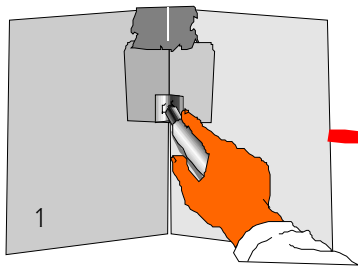
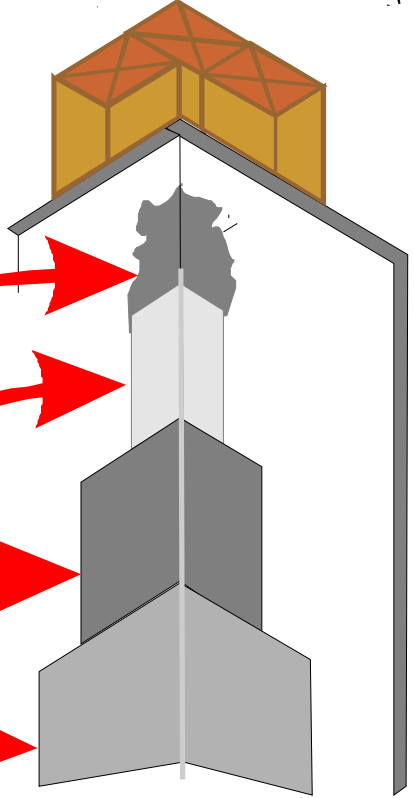
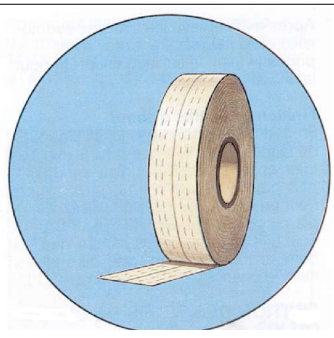

L. bodart

jointoiment d'angle rentrant de plaque en plâtre
avec une bande de papier perforée

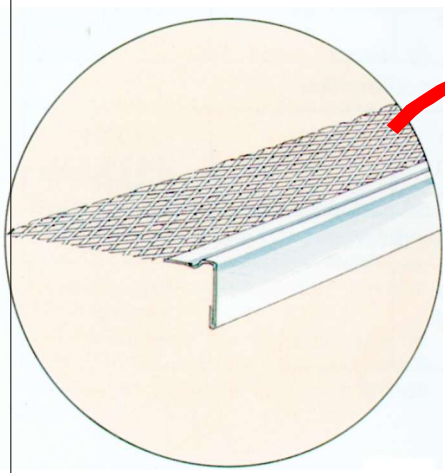
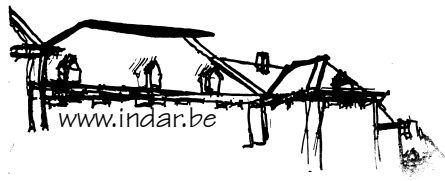

soit avec un profilé métallique adapté

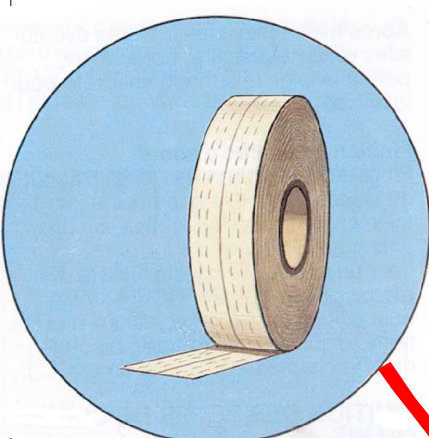

soit avec une bande d'armature en papier

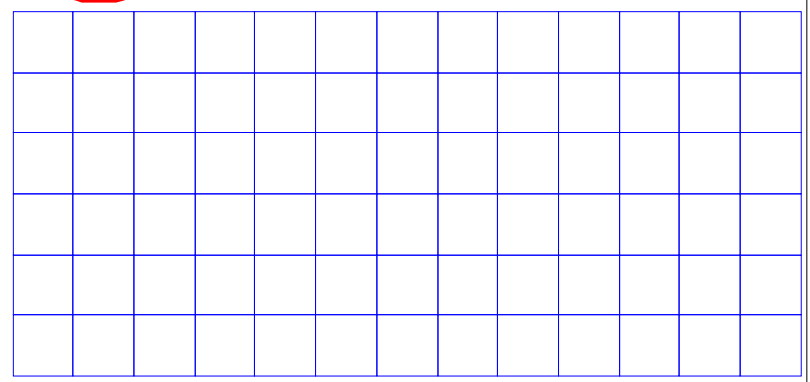
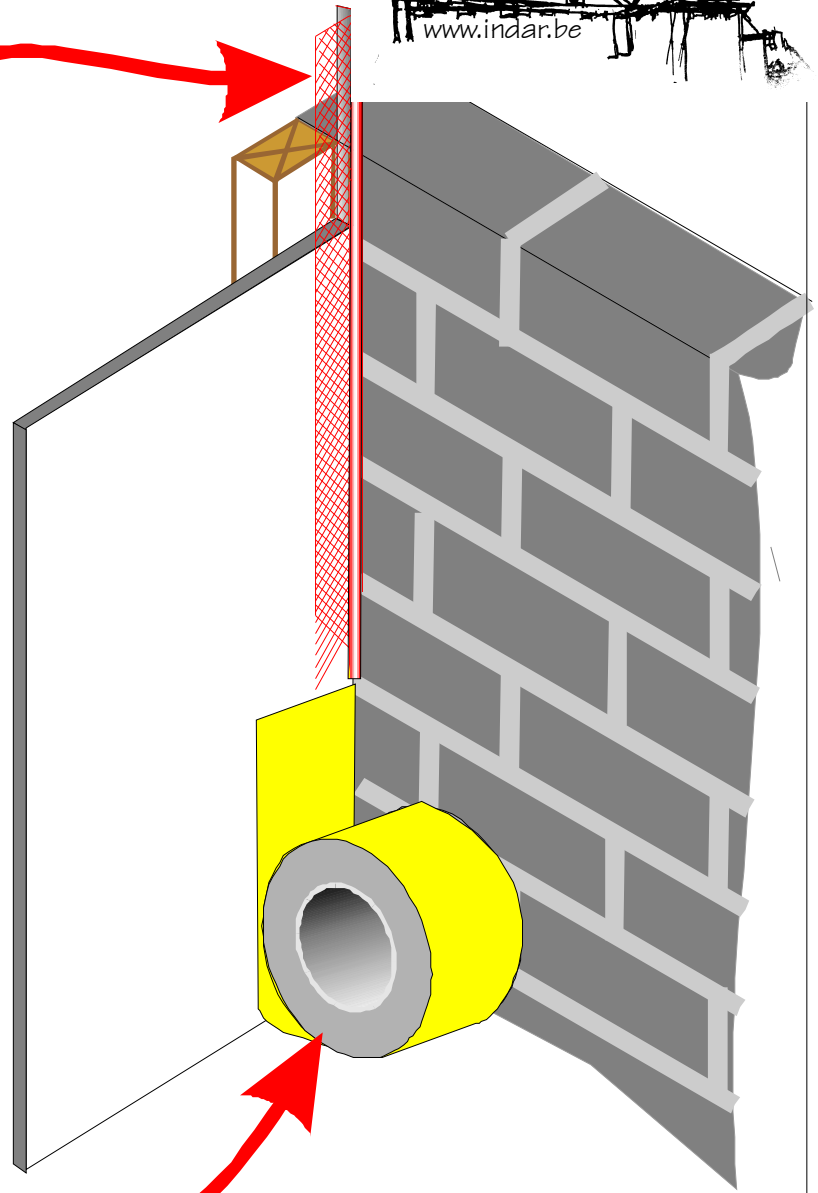

L. bodart

jointolement de plaque en plâtre avec d'autres matériaux

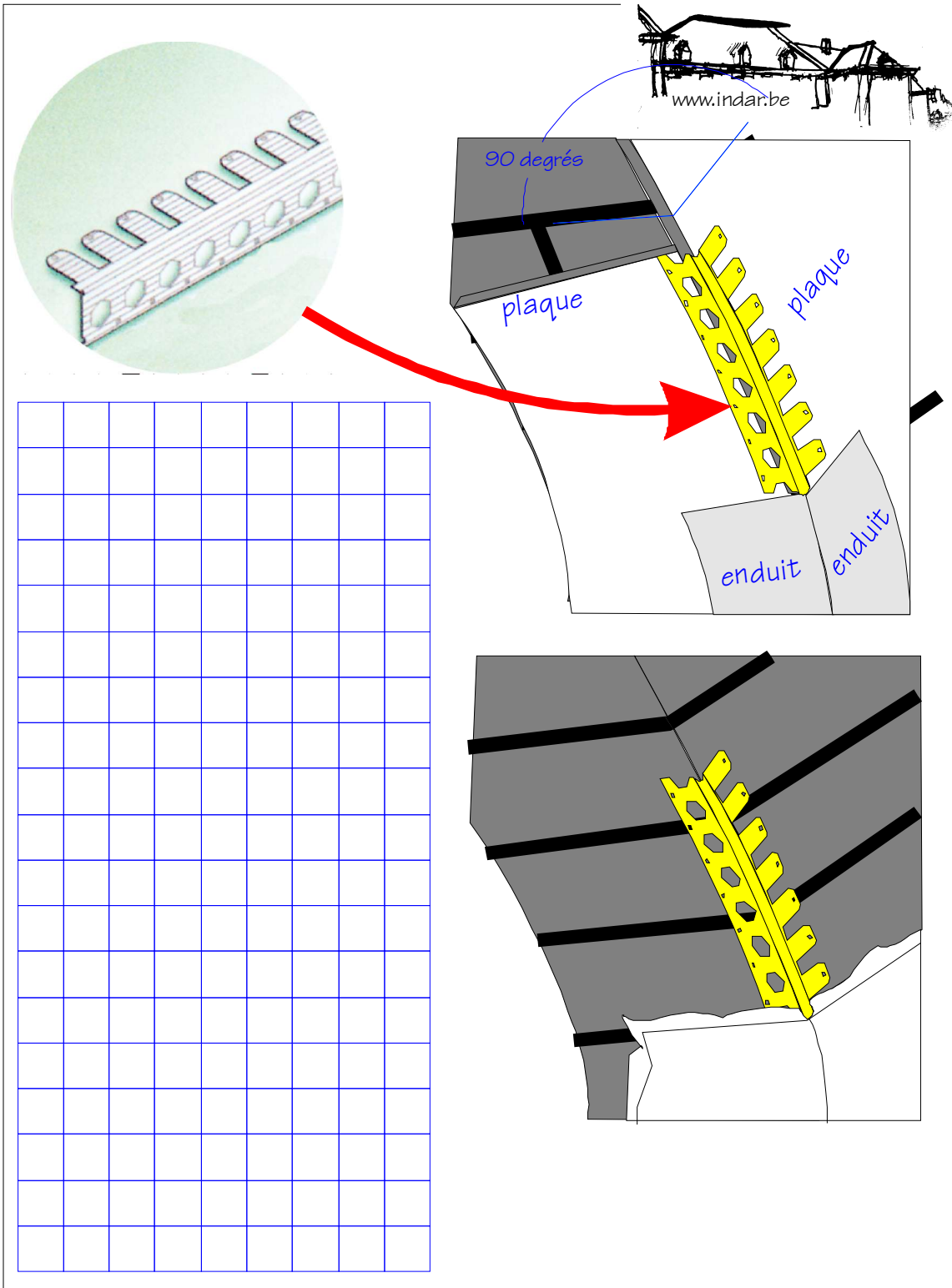

L. bodart

jointoiment d'angle sortant courbe (90 degrés) de plaque en plâtre avec un profilé de parachèvement et de renfort en PVC

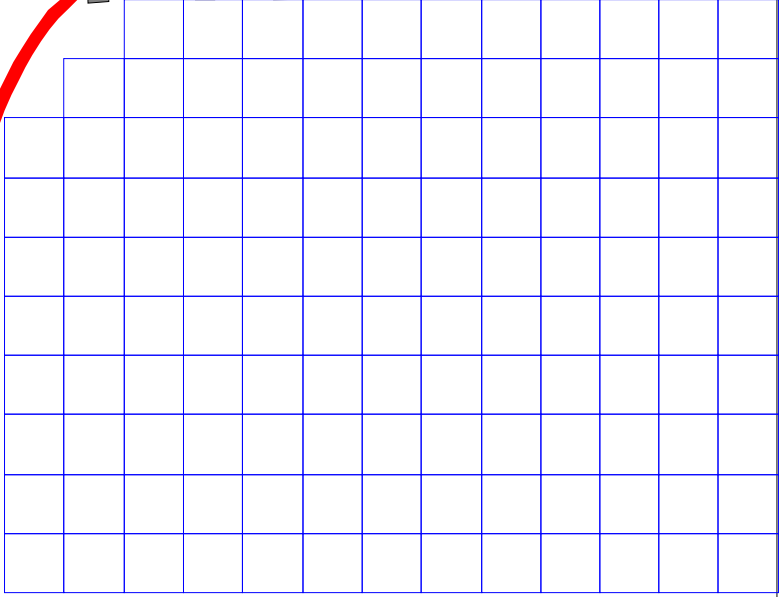
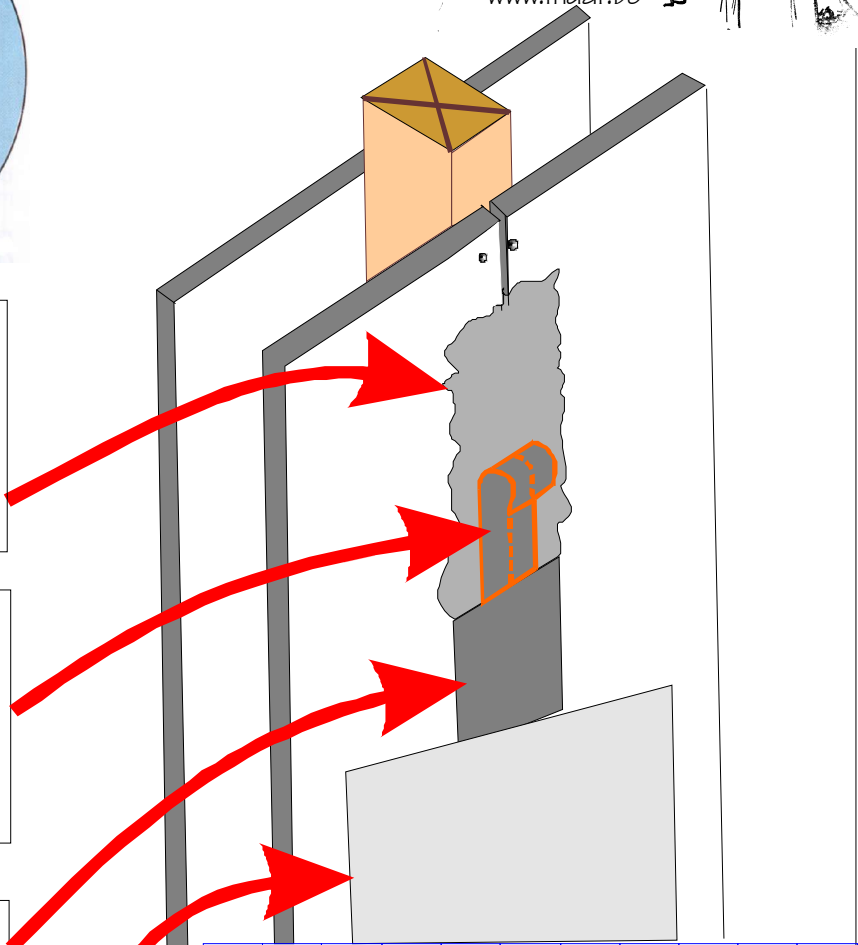
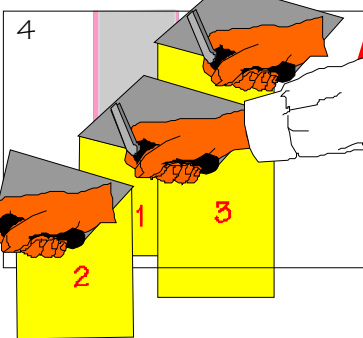
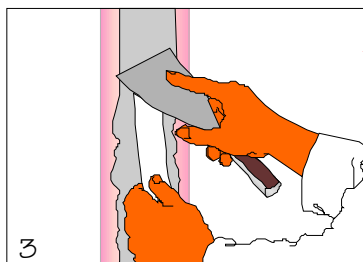
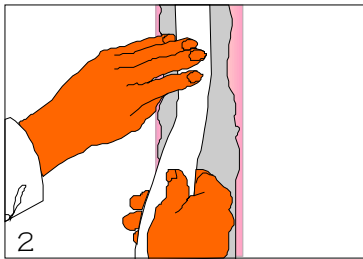
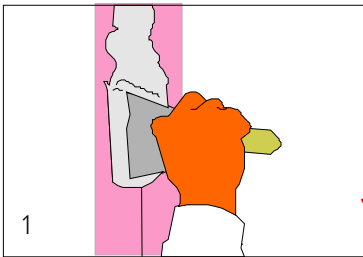
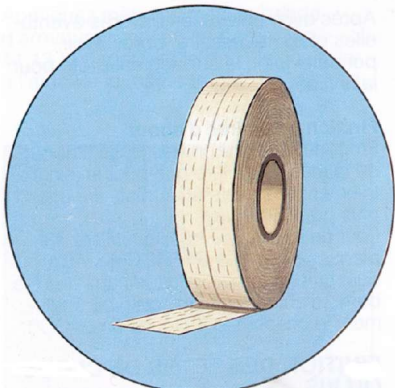

L. bodart

jointolement de plaque en plâtre à bords coupés ou droits
avec calicot en papier

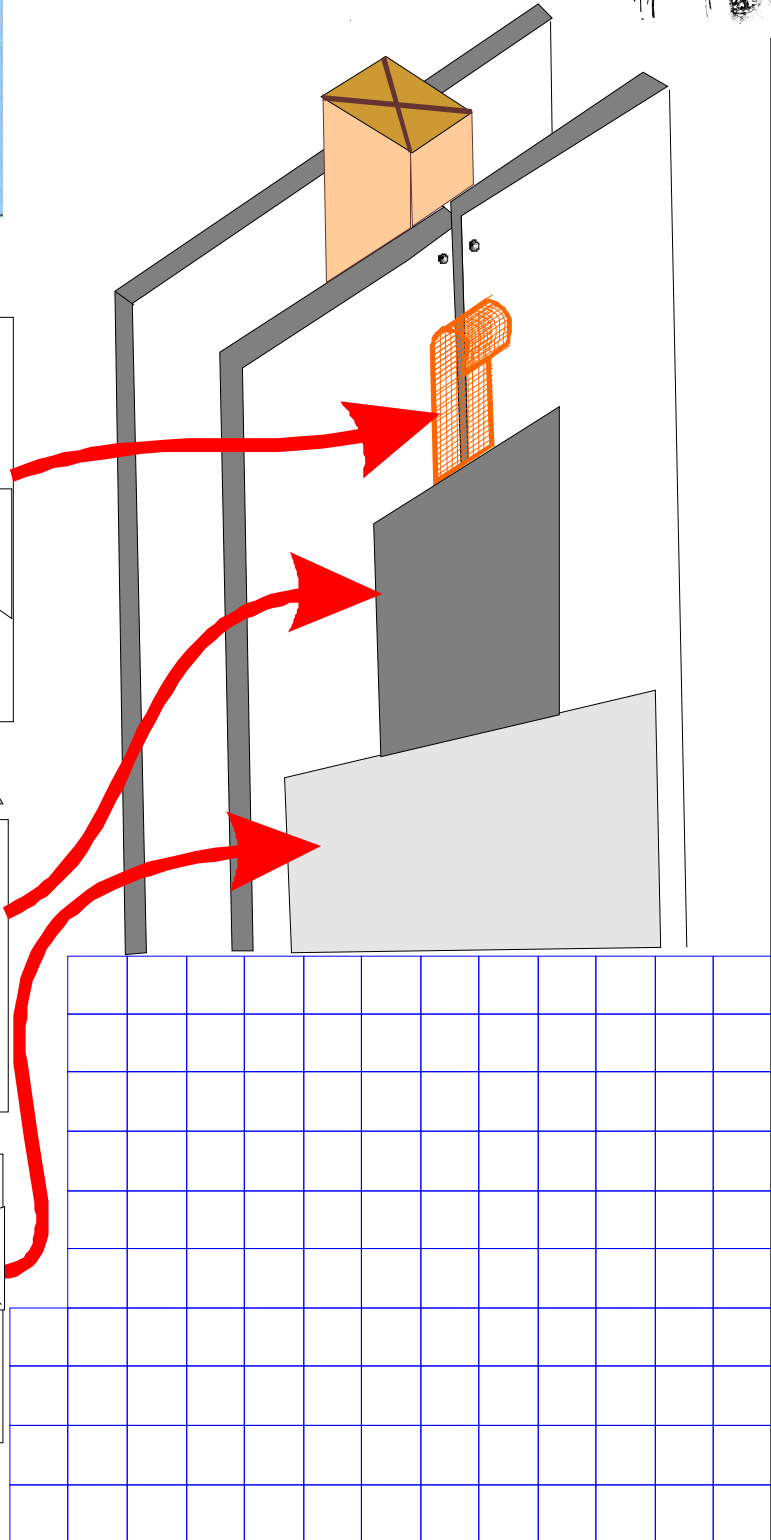
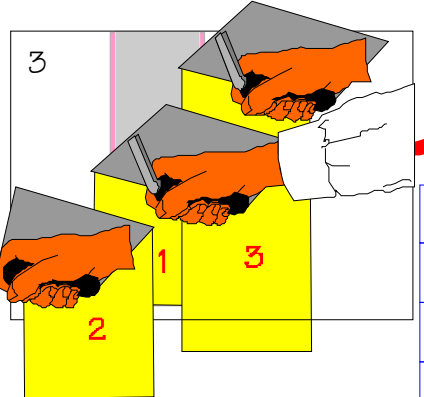
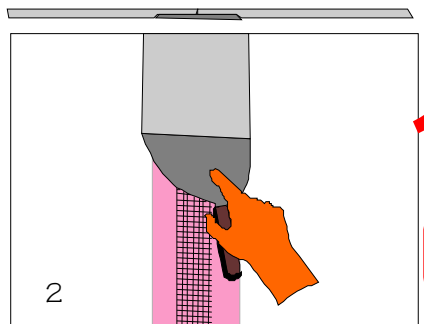
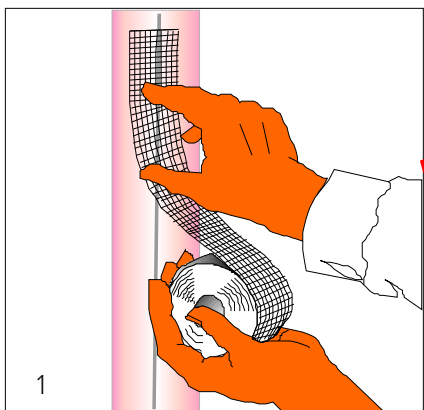
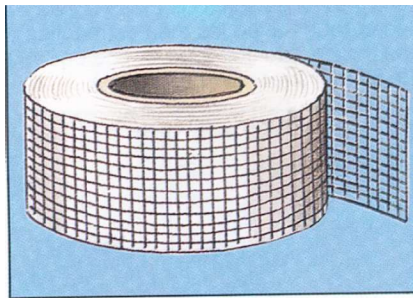

L. bodart

jointolement de plaque en plâtre à bords coupés ou droits avec une bande d'armature autocollante

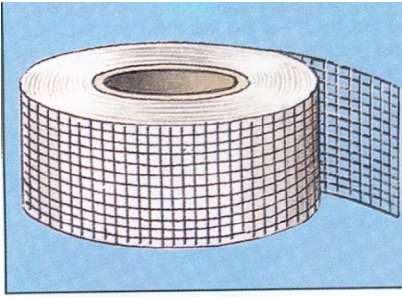

LES BANDES D'ARMATURES
NE DOIVENT JAMAIS SE
CHEVAUCHER
cela crée des sur épaisseurs

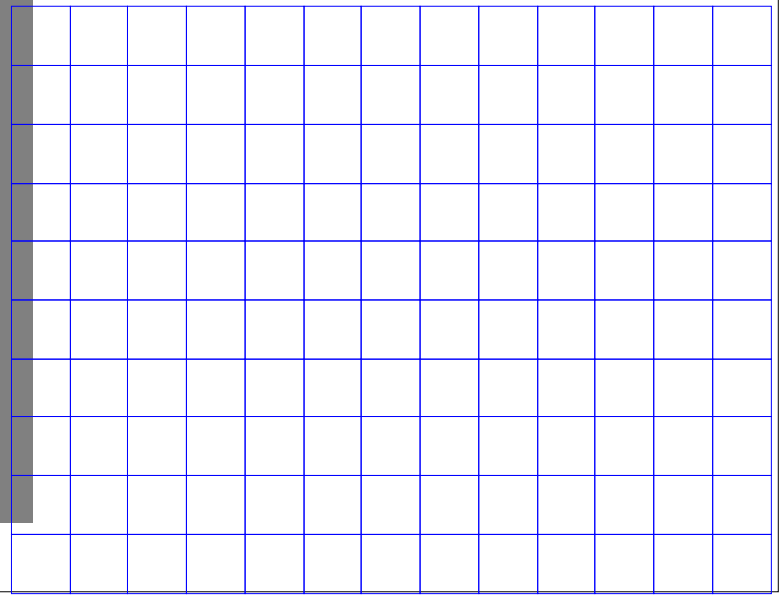
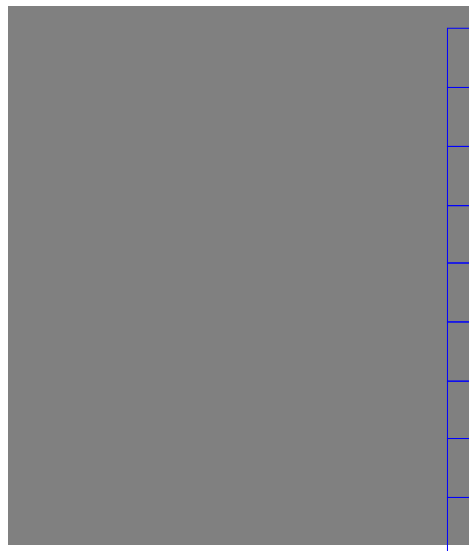
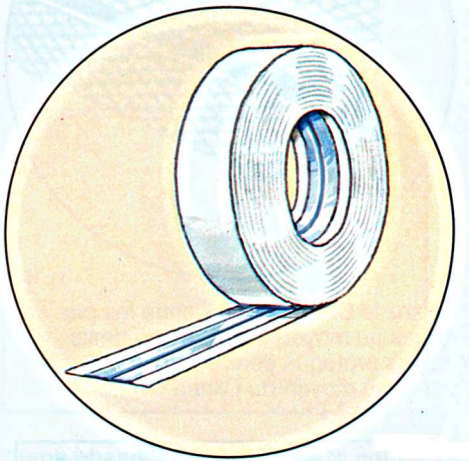
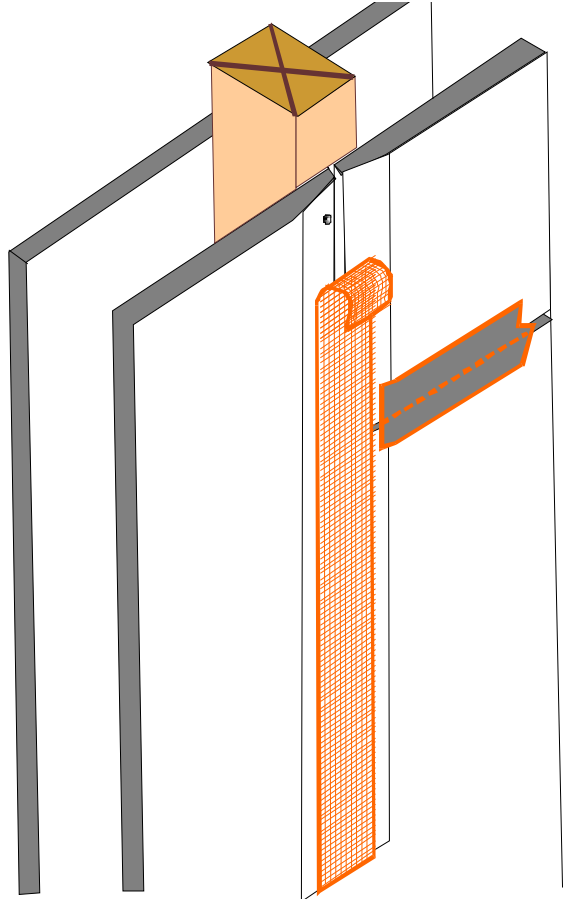

jointolement de plaque en plâtre
à bords coupés ou droits et bords amincis

Site sur les plaques de plâtre :

GYPROC

<http://www.gyproc.be/files/start.htm>

KNAUF

<http://www.knauf.be/>

LAFARGE

<http://www.lafarge-gypsum.be/fr/index.php>

d'autres documents de ce type se trouvent sur le site de notre école.

www.indar.be

visitez notre option

Aménagement d'intérieur,
Équipement du bâtiment,
Peinture

Bon travail

L. Bodart

decoration@decoration.be.tf