

F
I
C
H
E

P
A
R
C
O
U
R
S
G
Y
M
N
-
Q
U
E

N
-
I
V
E
A
U

4

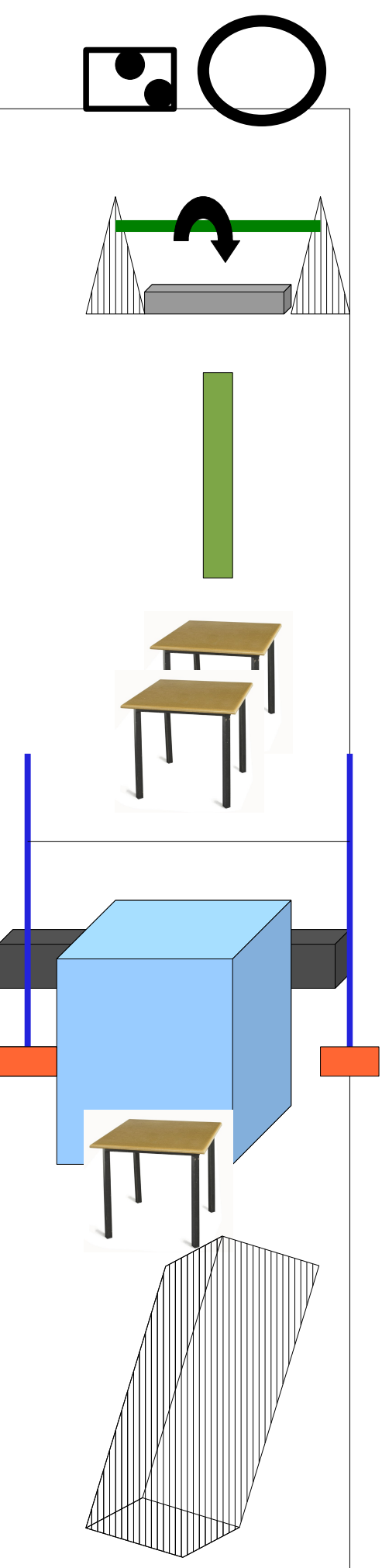
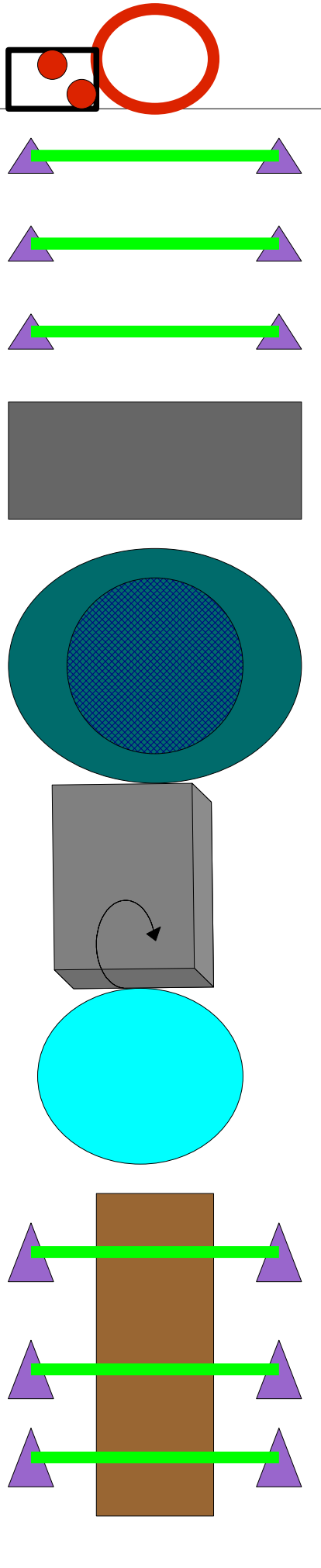
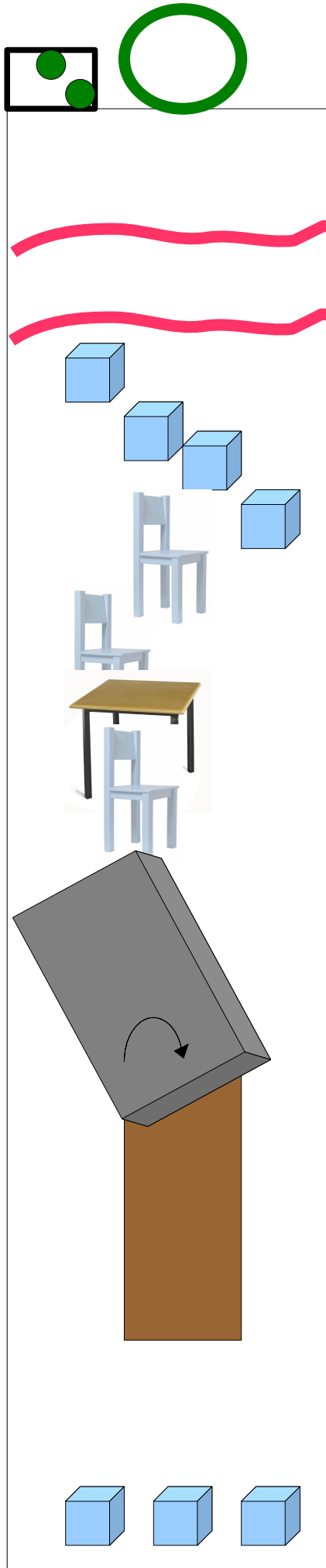

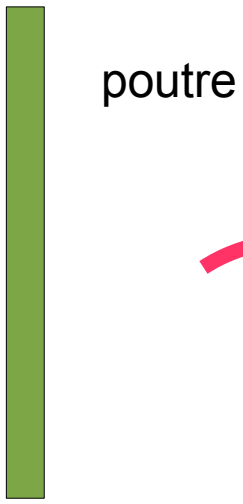

poutre



boîte à gommettes



table



corde pour symboliser une rivière à franchir



poteaux + élastique + tapis



caissette



petites échelles + barre

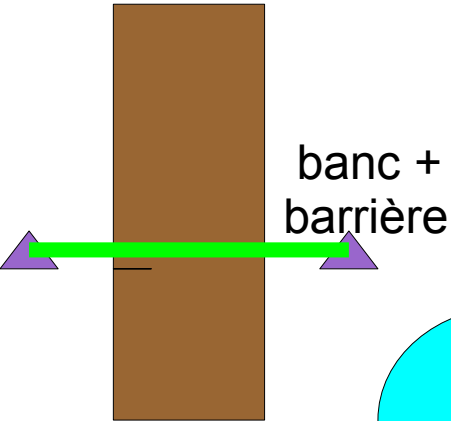

banc + barrière

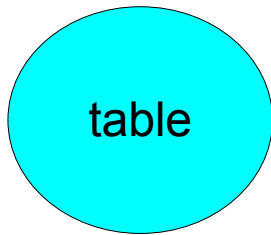

table

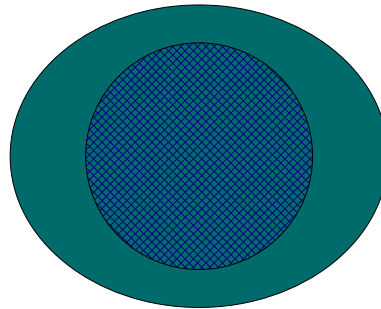

trampoline



tapis

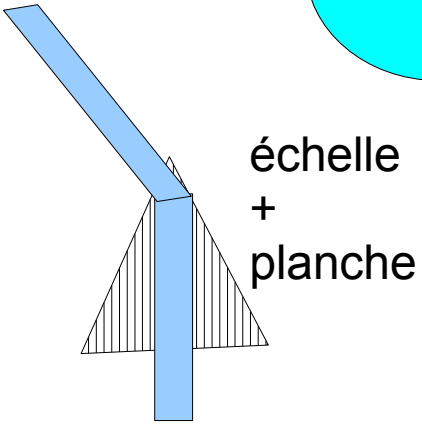

échelle + planche



barrière







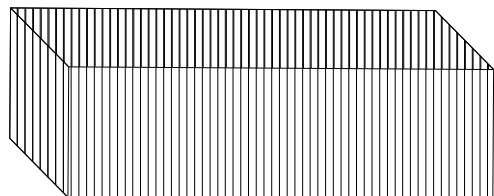

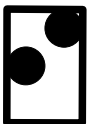

petite chaise

échelle retournée pour ramper dessous ou marcher dessus

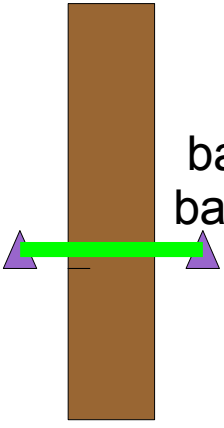

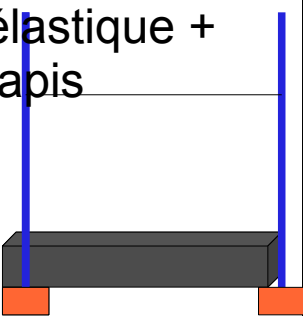
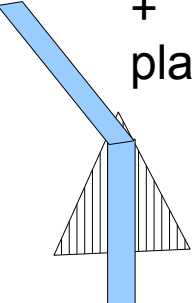
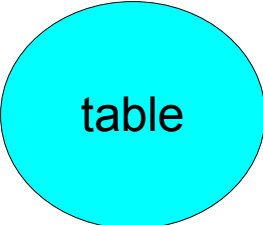
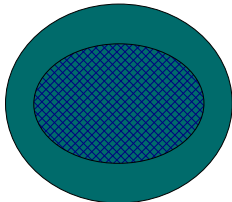
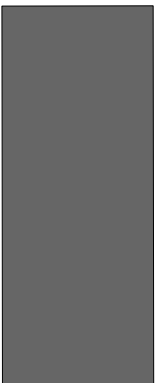
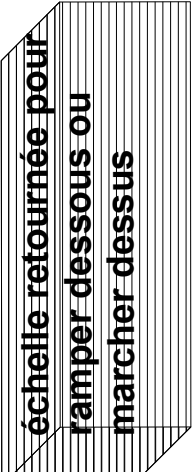
tapis

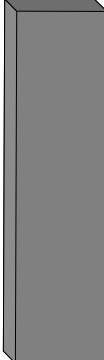
 <p>poutre</p>	 <p>corde pour symboliser une rivière à franchir</p>	<p>boîte à gommettes</p> 	<p>table</p> 
 <p>banc + barrière</p>	 <p>petites échelles + barre</p>	 <p>caissette</p>	<p>poteaux + élastique + tapis</p> 
<p>échelle + planche</p> 	 <p>table</p>	<p>trampoline</p> 	 <p>tapis</p>
<p>échelle retournée pour ramper dessous ou marcher dessus</p> 	<p>barrière</p> 	 <p>tapis</p>	<p>petite chaise</p> 