

a a A a A



l'ananas

l'ananas

i I i I

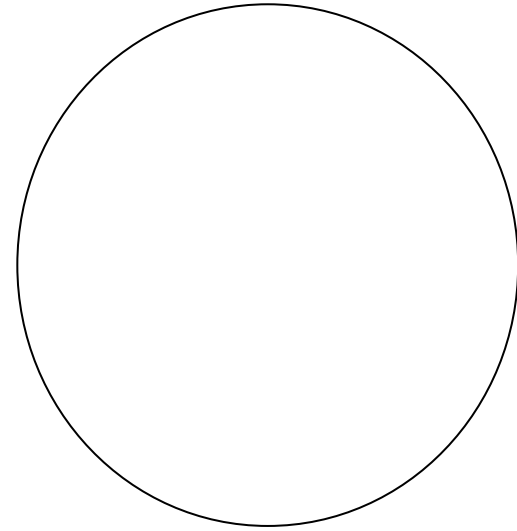

gris

gris

y Y y Y

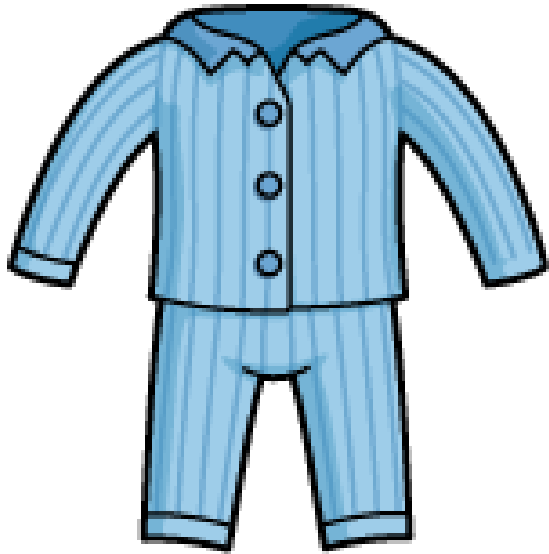

le pyjama

le pyjama

r R r R

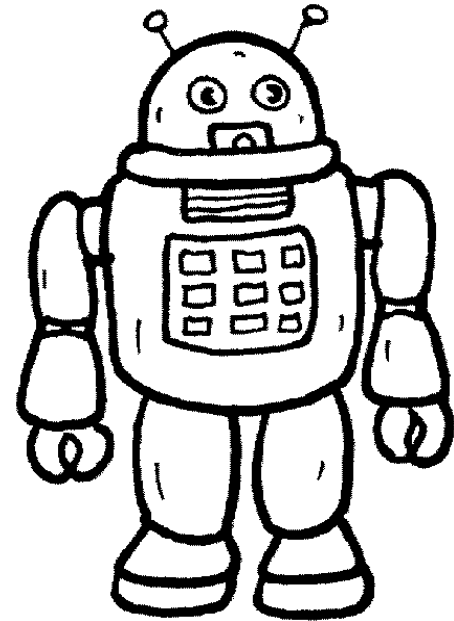

le robot

le robot

l L l L

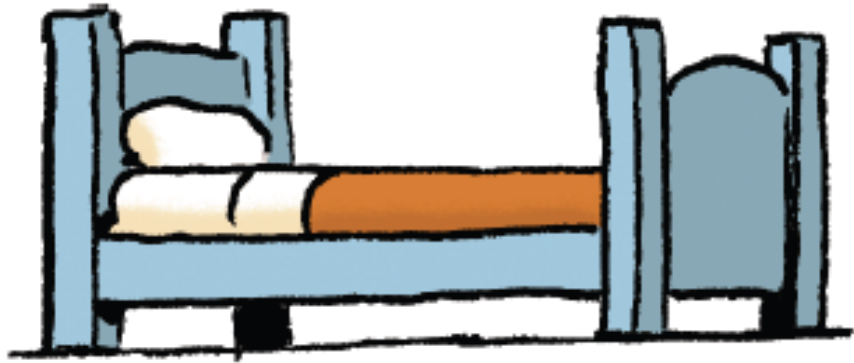

le lit

le lit

o O o O

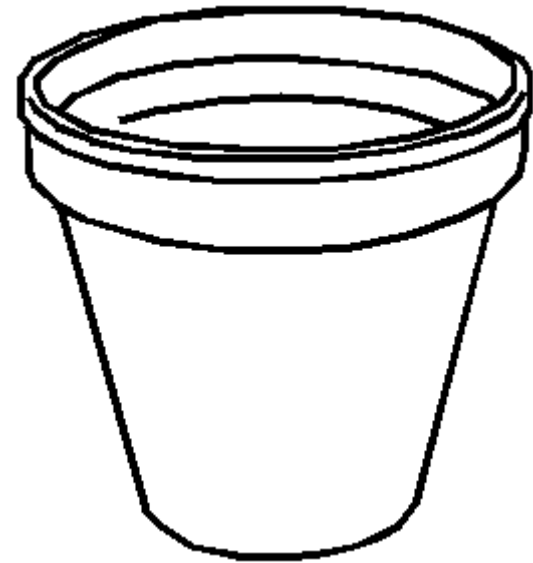

le pot

le pot

é É é



l'épée
l'épée

s S s S

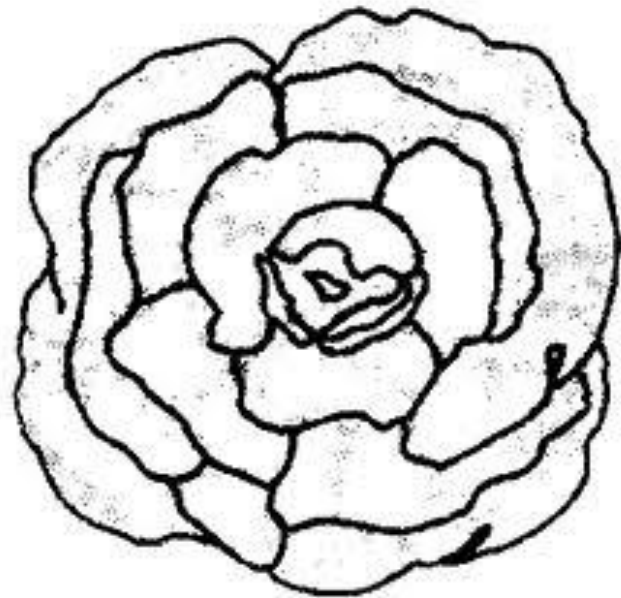

la salade
la salade

u U u U



la rue
la rue

f F f F



le fantôme
le fantôme

e E e È

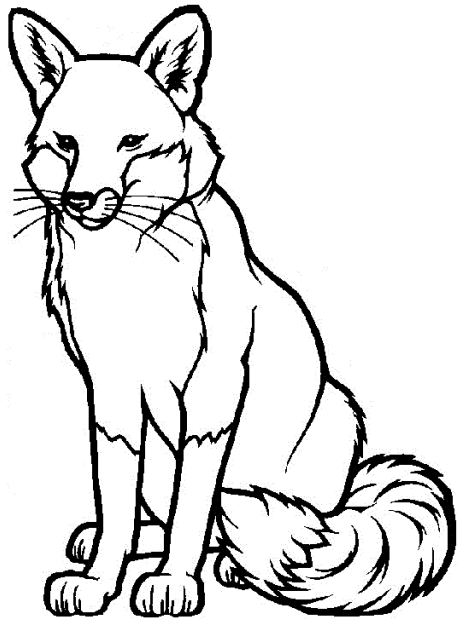

le renard

le renard

m M m M

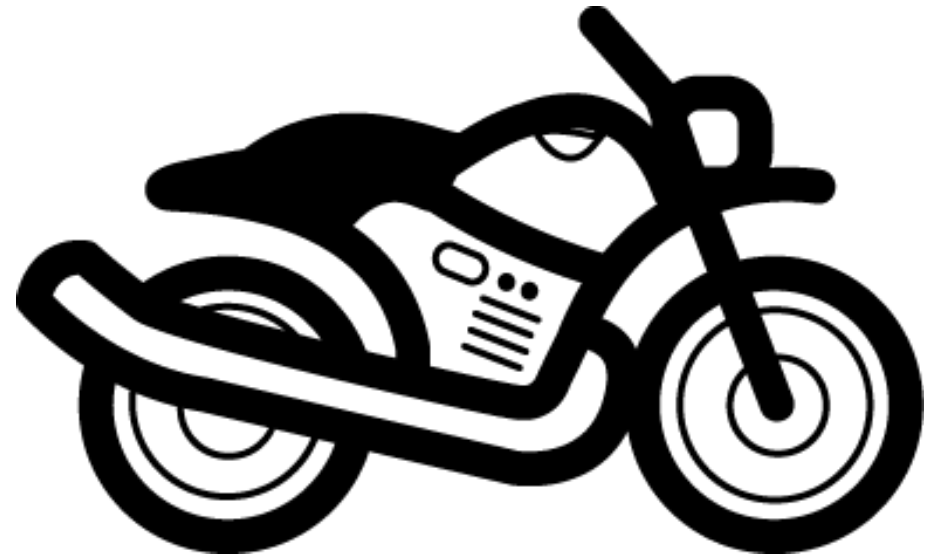

la moto

la moto

ch ch

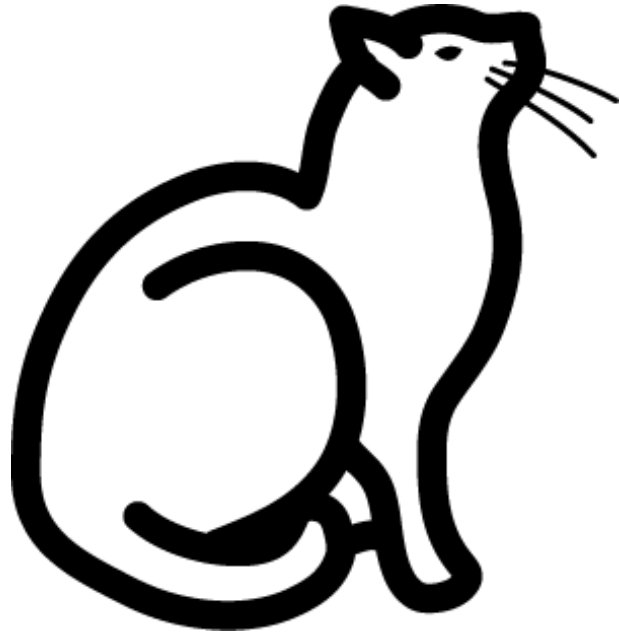

le chat

le chat

n N n N

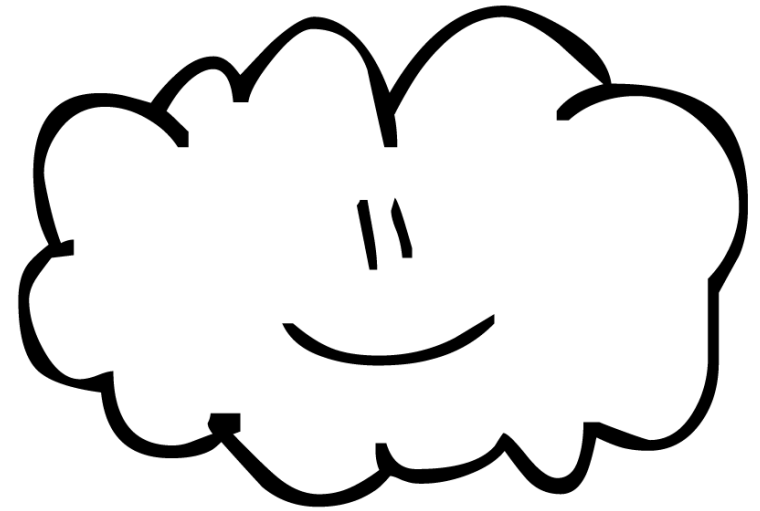

le nuage

le nuage

è È è

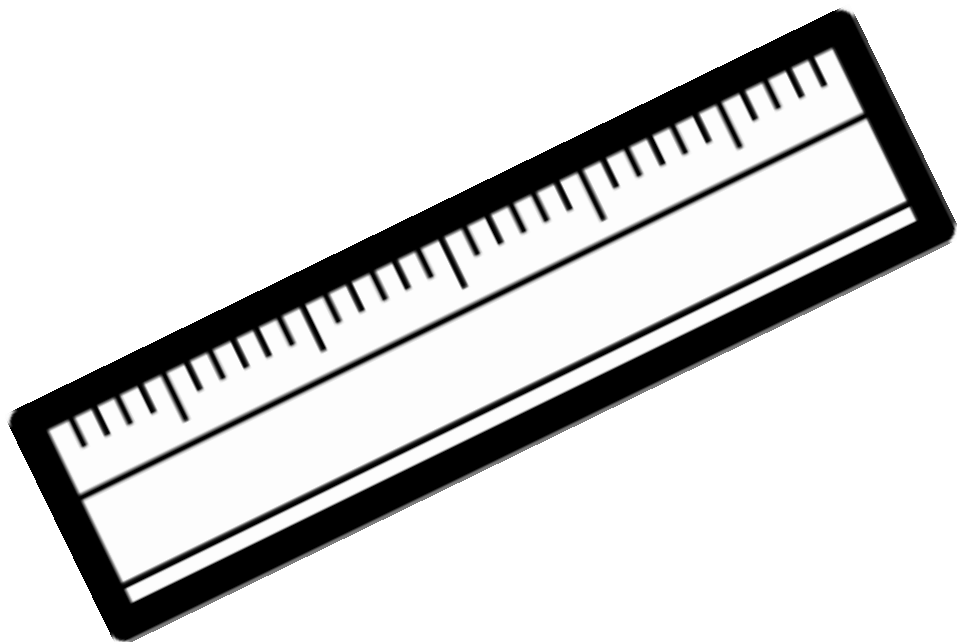

la règle
la règle

ê Ê ê

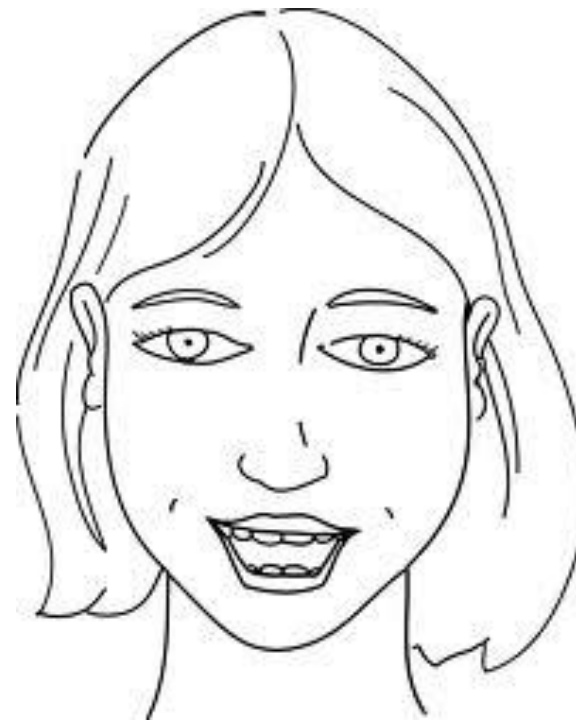

la tête
la tête

v V v V



le vélo

le vélo

ou ou

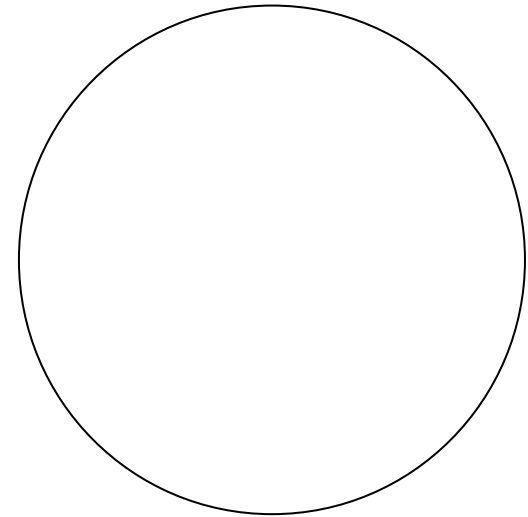

rouge

rouge

z Z z Z

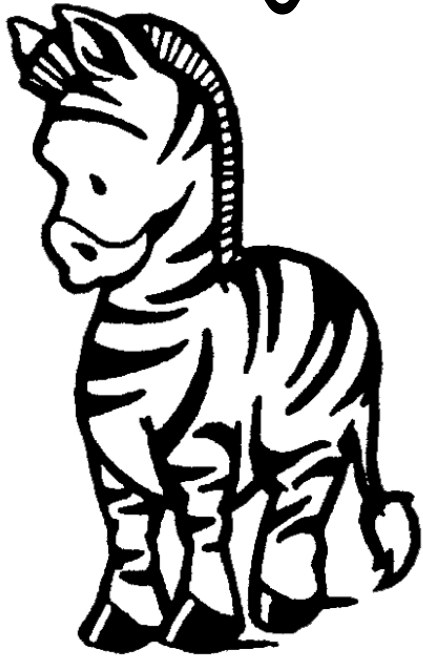

le zèbre

le zèbre

p P p P



le pied

le pied

c C c C

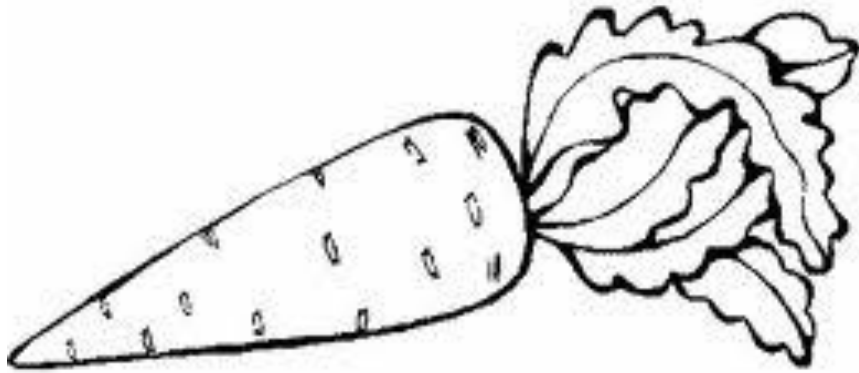

la c carotte
la c carotte

b B b B



le b ballon
le b ballon

j J j J

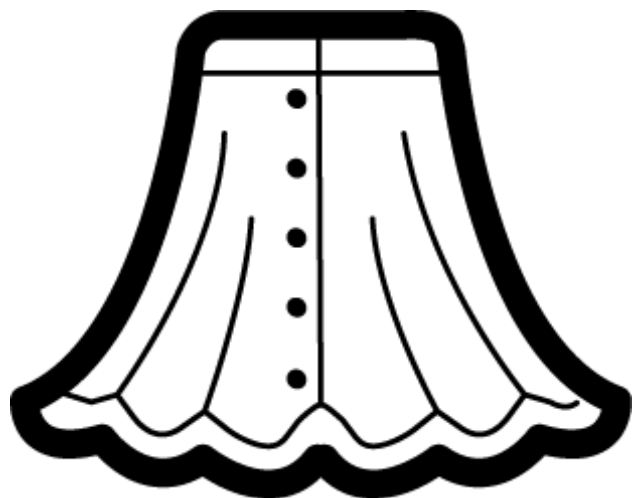

la jupe

la jupe

g G g G



le gâteau

le gâteau

d D d D

2

deux

deusc

an an

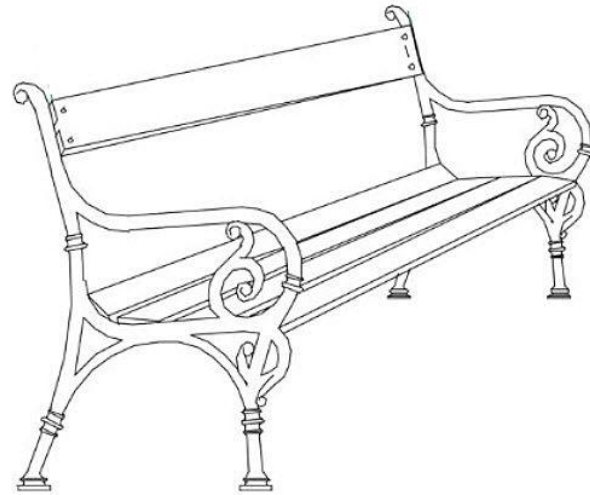

le banc

le banc

en en

100

cent

cent

t T t T



la table

la table

h H h H

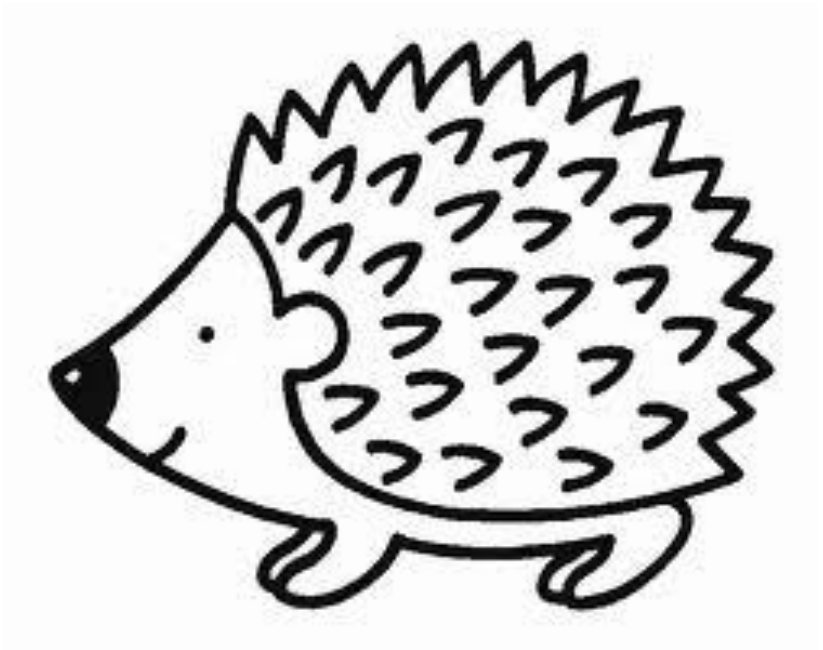

le h érisson

le h érisson

in in



le lapin

le lapin

on on

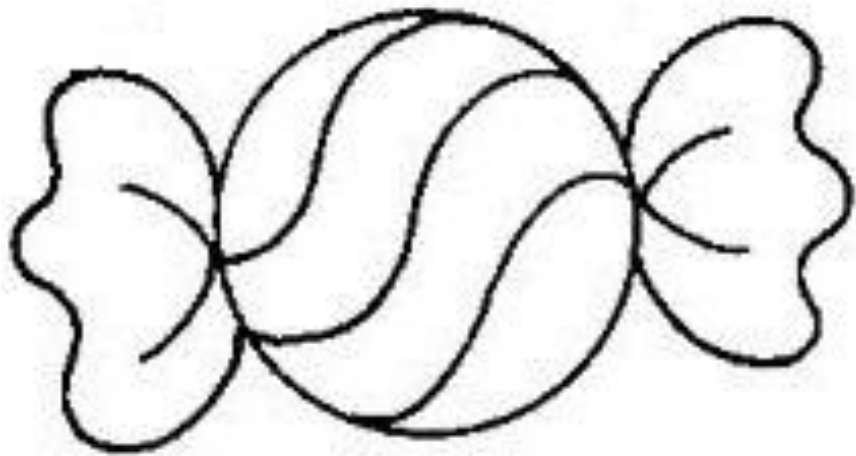

le bonbon

le bonbon

oi oi

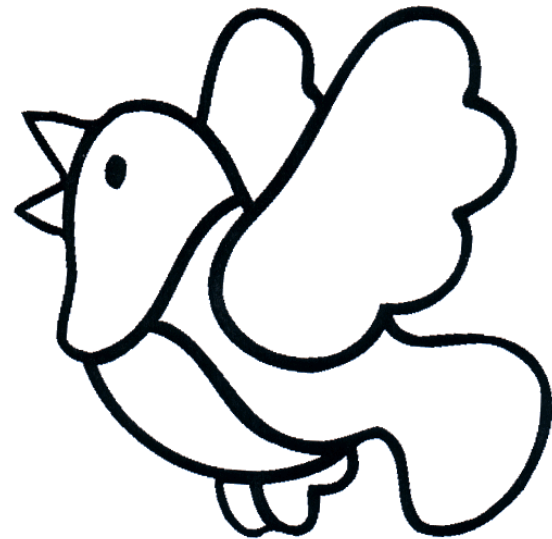

l'oiseau

l'oiseau

au au

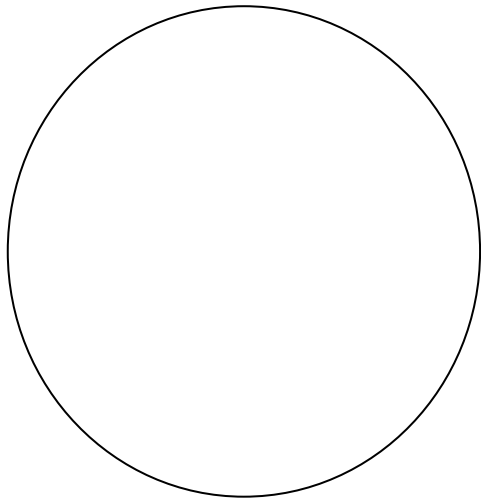

jaune

jaune

ai ai

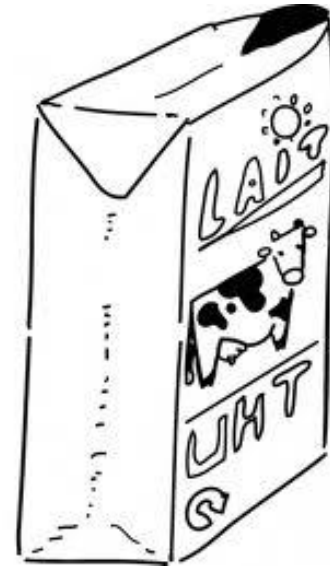

le lait

le lait

ei ei



la reine

la reine

et et

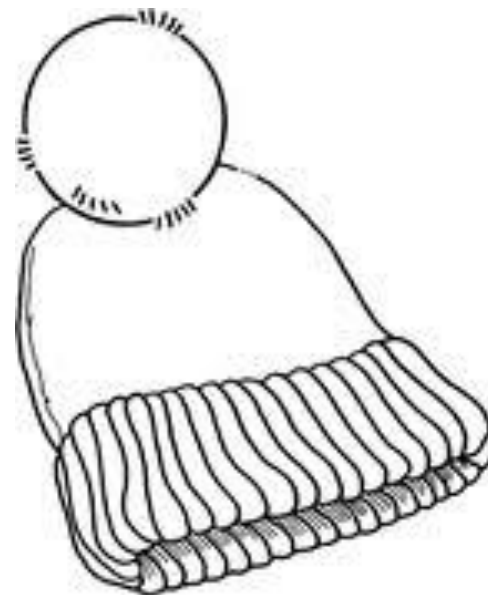

le bonnet

le bonnet

er er



le cahier

le cahier

ez er



le nez

le nez

q q

5

cinq

cinq

k k



le kangourou

le kangourou

ch ch

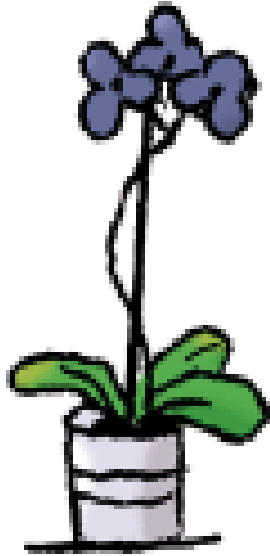

l'orchidée

l'orchidée

eu eu

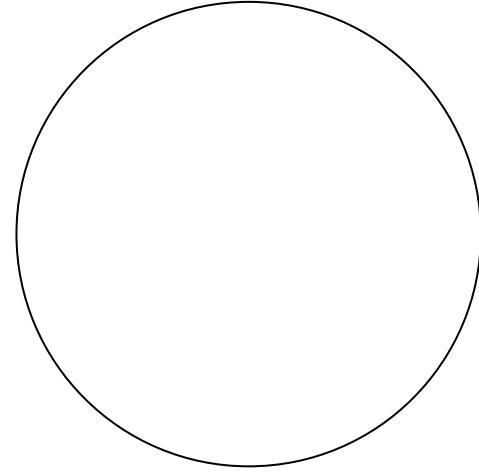

bleu

bleu

eu eu

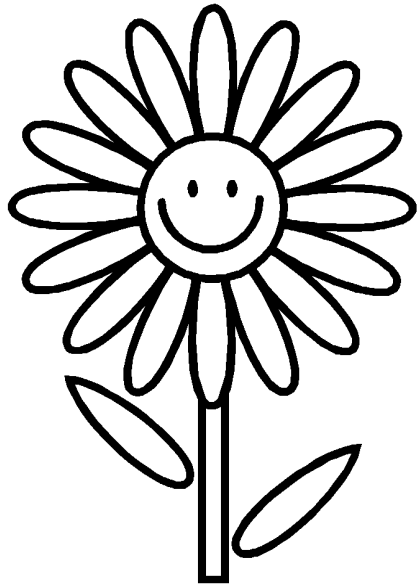

la fleur
la fleur

œu œu



le nœud
le nœud

œu

œu

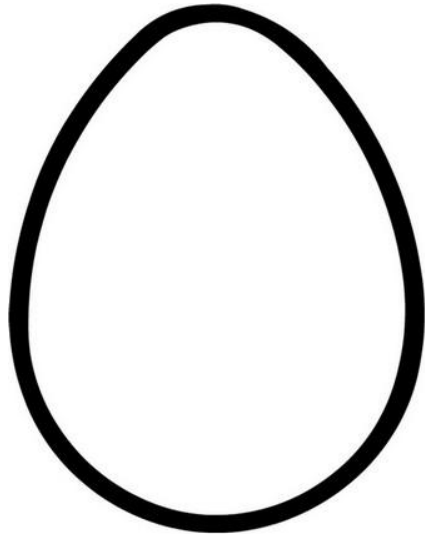

l'œuf

l'œuf

gu

gu



la guitare

la guitare

ge ge

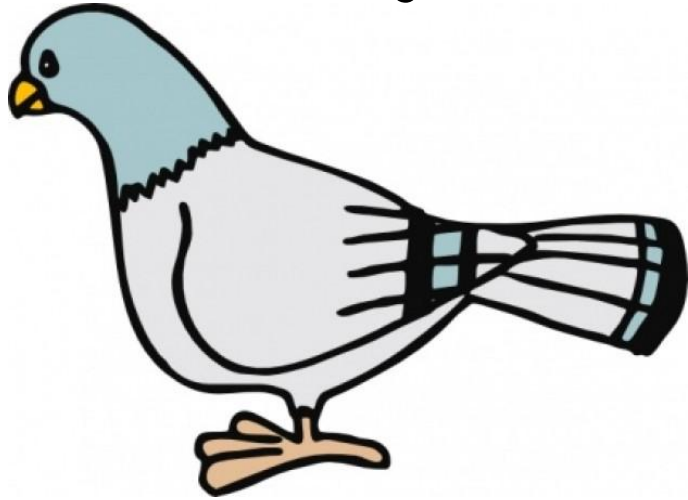

le pigeon
le pigeon

ain ain



la main
la main

ein ein

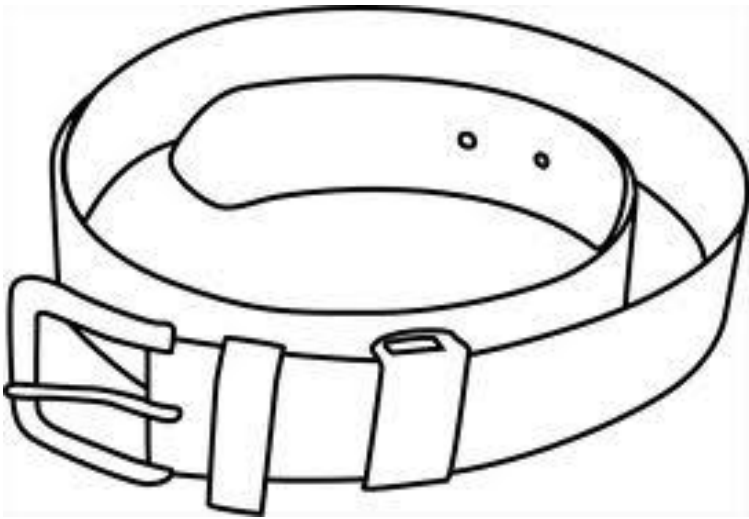

la ceinture

la ceinture

aim aim



le daim

le daim

eau eau

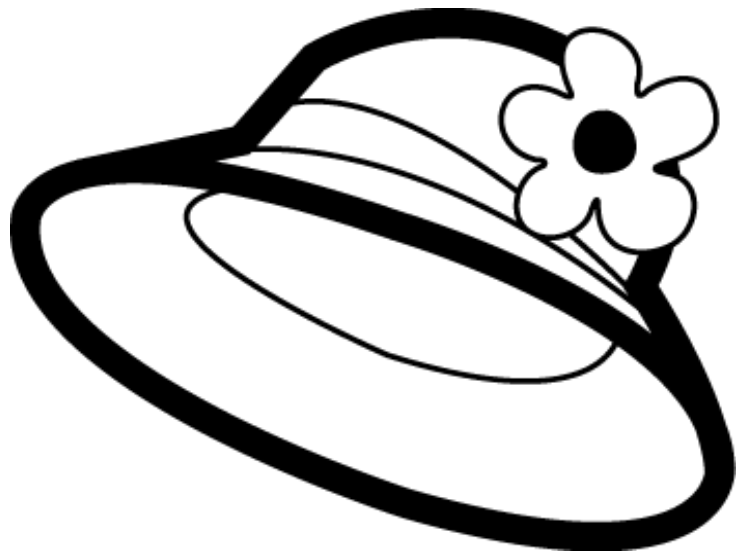

le chapeau
le chapeau

oin oin

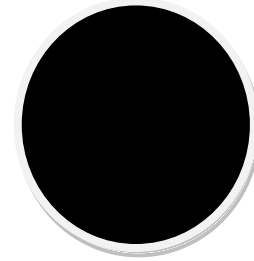

le point
le point

S = Z

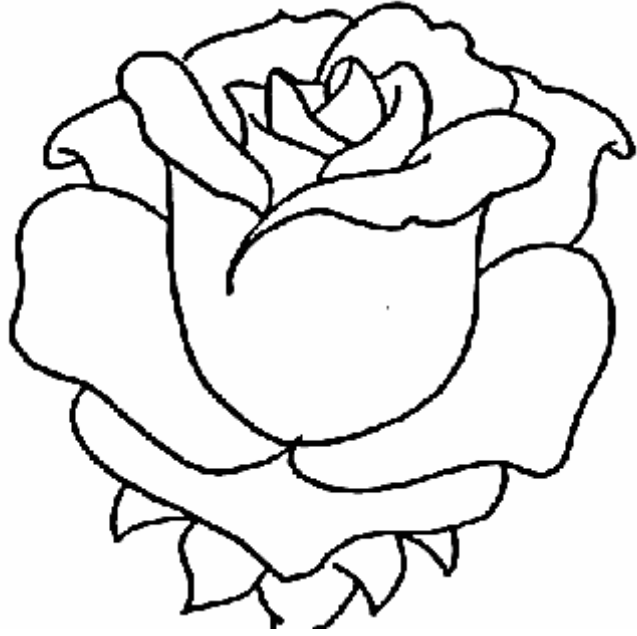

la rose

la rose

ph ph

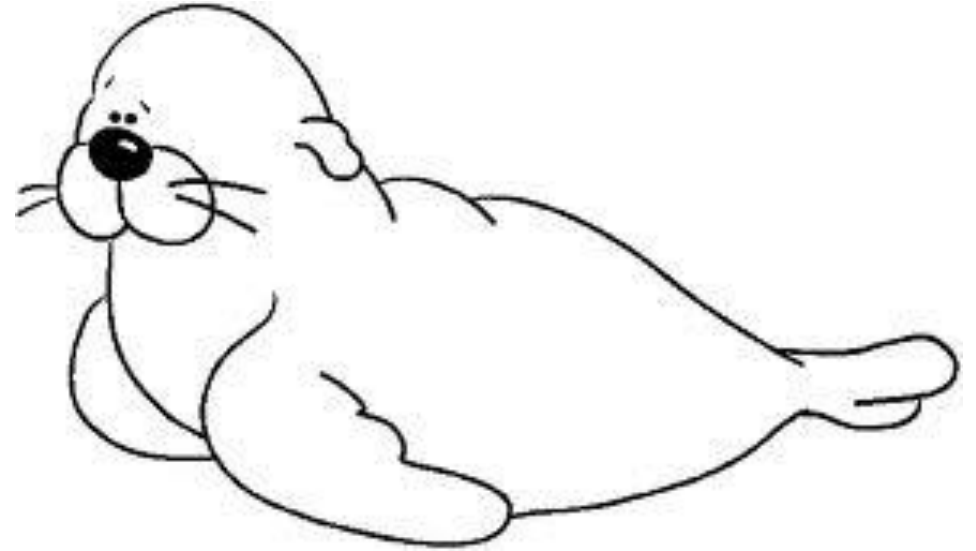

le phoque

le phoque

ce ce

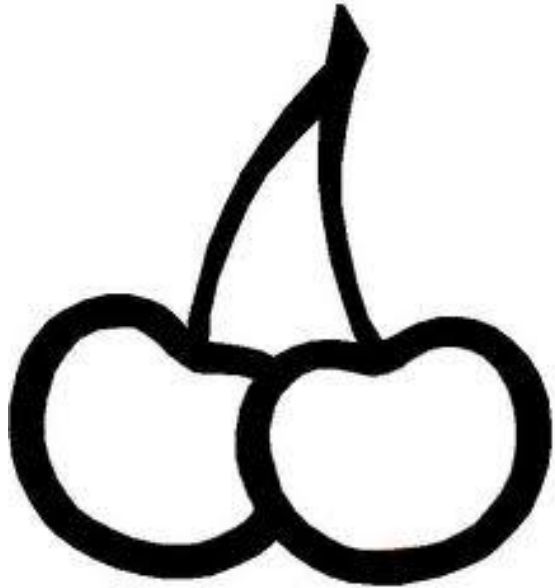

les cerises

les cerises

ci ci

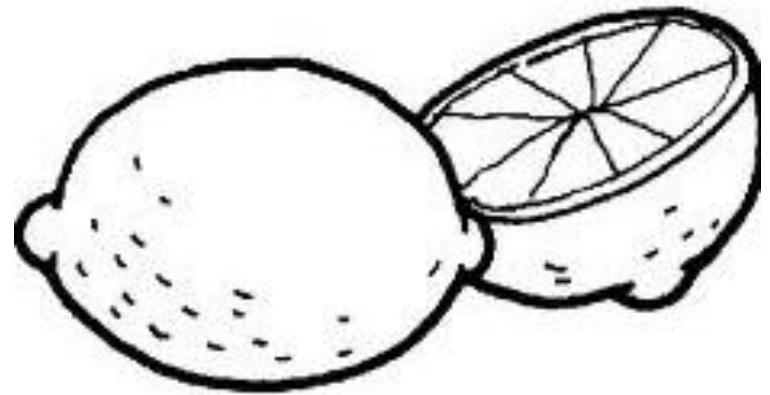

le citron

le citron

ç ç

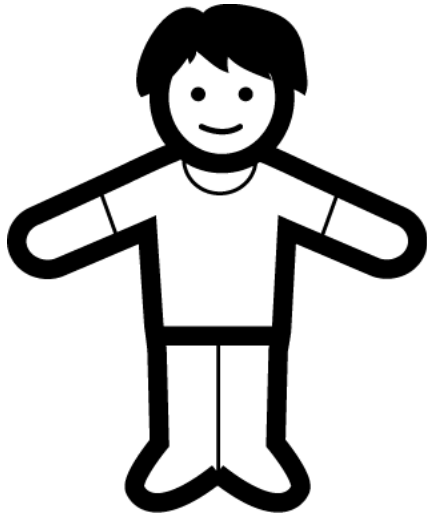

le garçon
le garçon

e = è

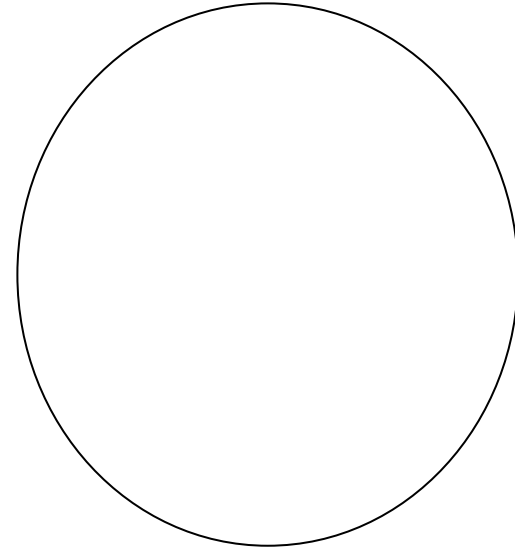

vert
vert

gn gn



le peigne
le peigne

ill ill

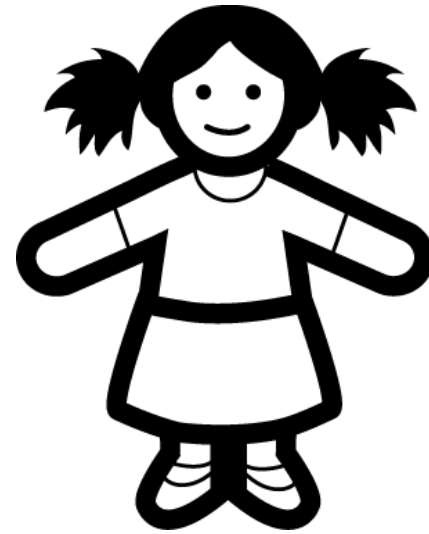

la fille
la fille

y y

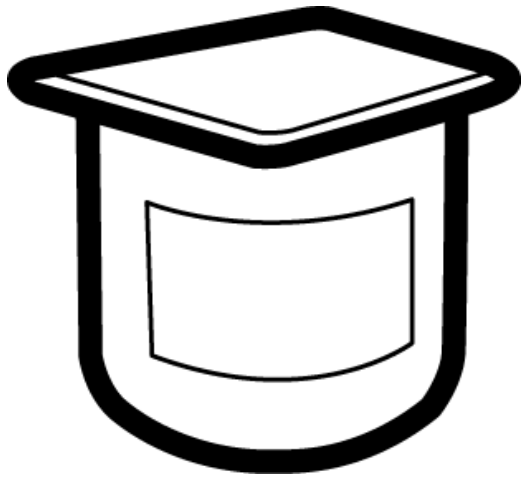

le yaourt
le yaourt

ail ail

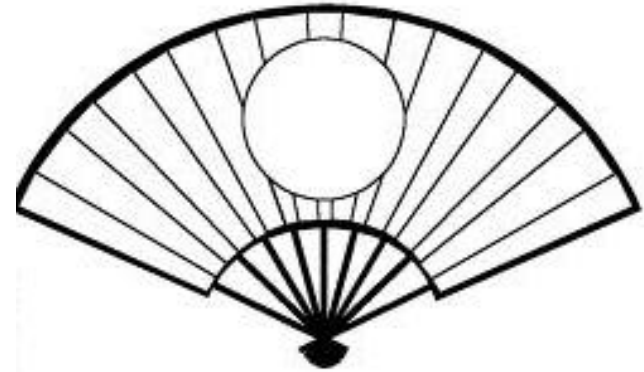

l'éventail
l'éventail

eil eil

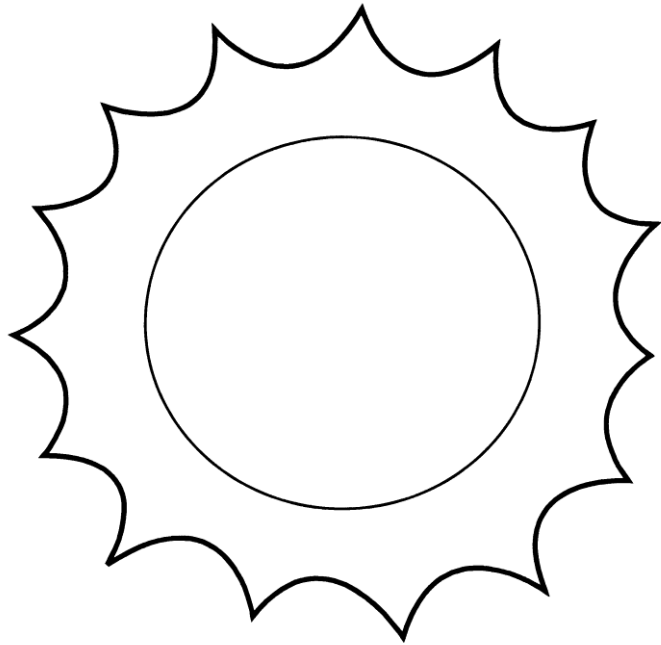

le soleil

le soleil

aill aill

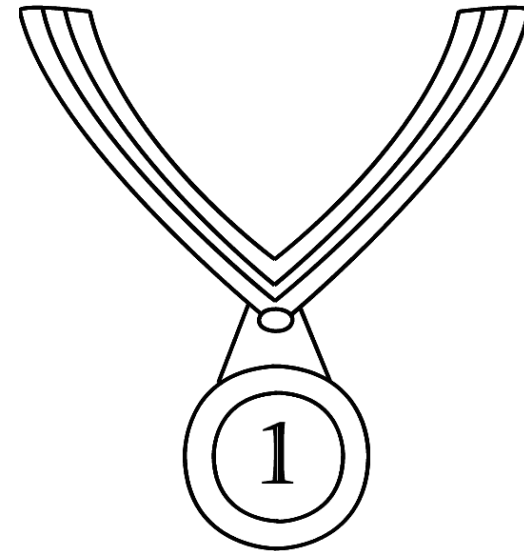

la médaille

la médaille

eill eill

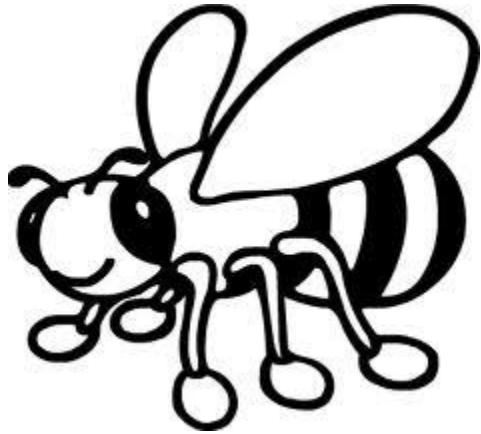

l'abeille

l'abeille

euil euil



l'écureuil

l'écureuil

euill euill



la feuille

la feuille

ouill ouill



la citrouille

la citrouille

ian ian

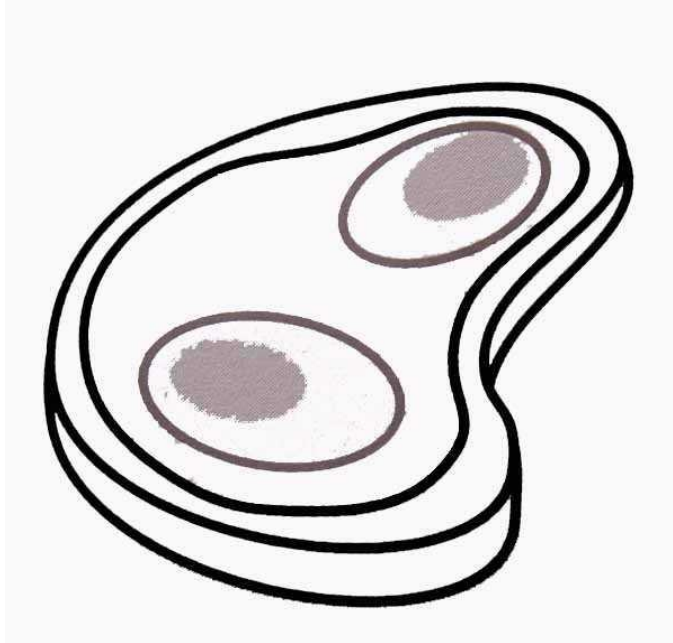

la viande

la viande

ien ien

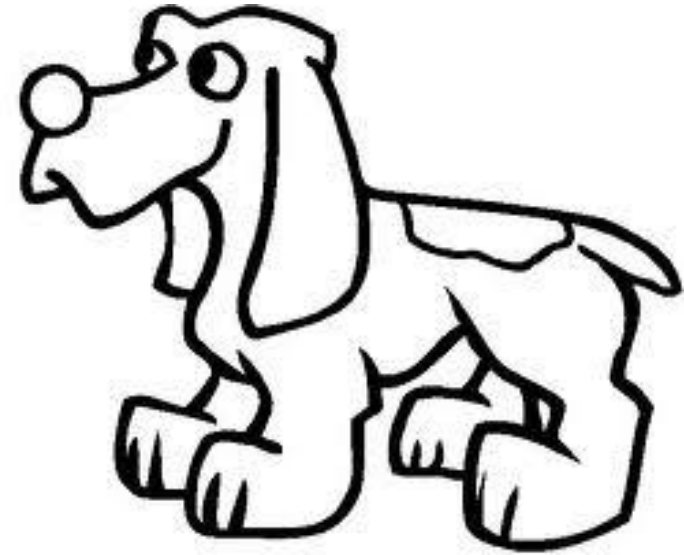

le chien

le chien

ieu ieu

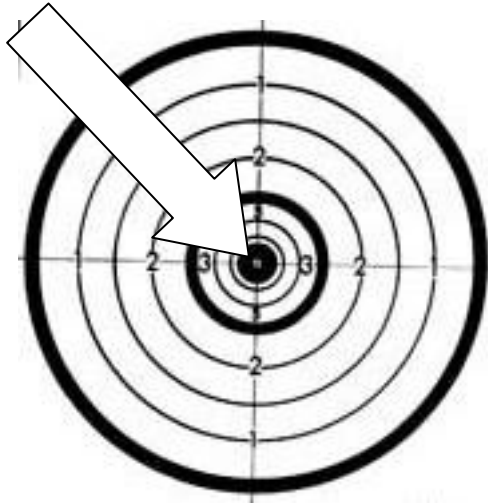

le milieu

le milieu

ion ion

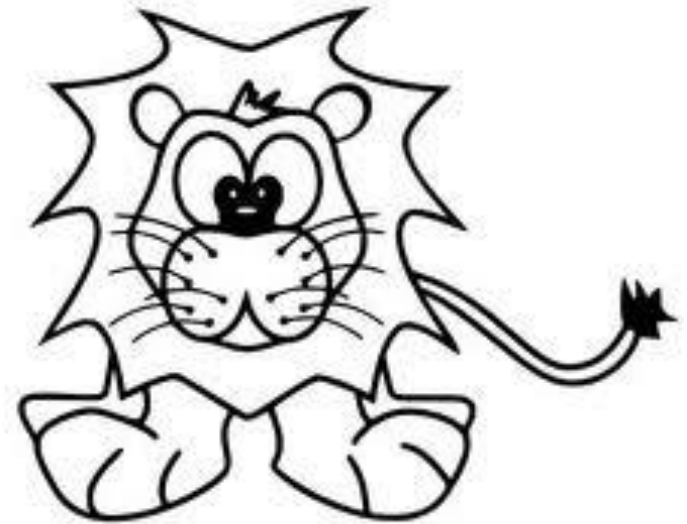

le lion

le lion

ti = si

2+2=4

l'addition

l'addition

x X ∞ ℋ

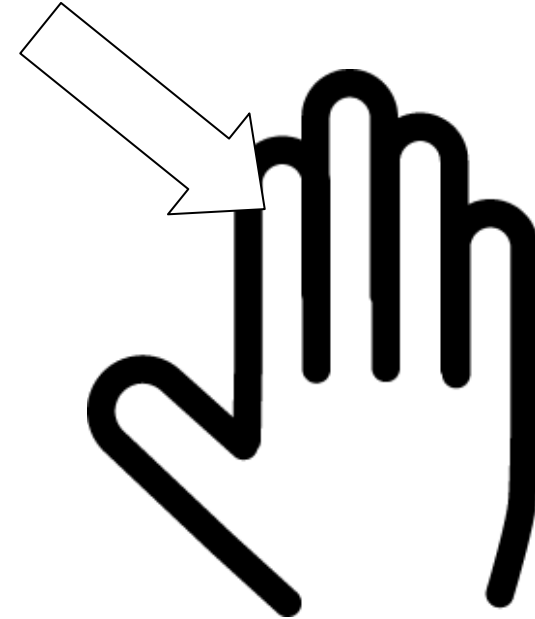

l'index

l'index

x X ∞ ℘

x X ∞ ℘

6

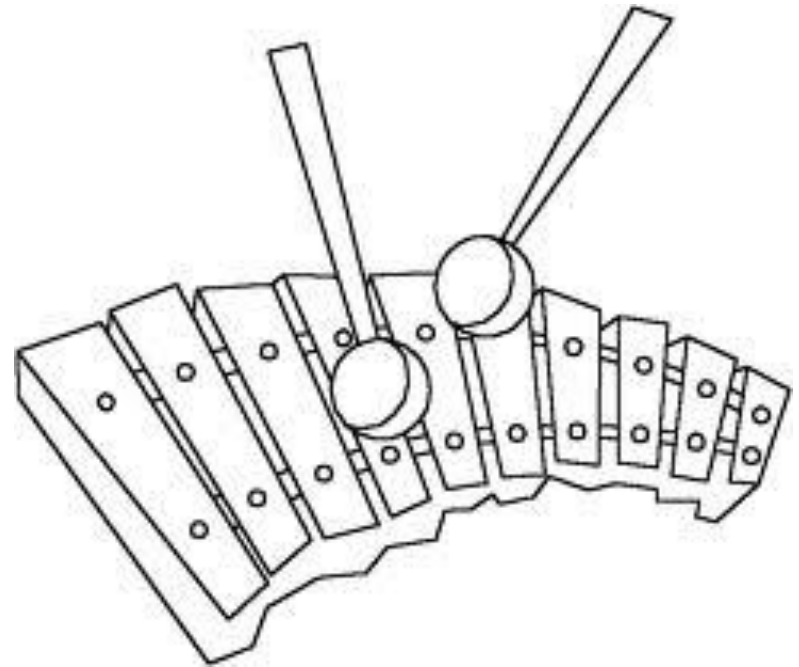

six

sicc

le xylophone

le cxylophone