

Is “the theory of everything” merely the ultimate ensemble theory?

Max Tegmark

Institute for Advanced Study, Olden Lane, Princeton, NJ 08540; max@ias.edu

We discuss some physical consequences of what might be called “the ultimate ensemble theory”, where not only worlds corresponding to say different sets of initial data or different physical constants are considered equally real, but also worlds ruled by altogether different equations. The only postulate in this theory is that all structures that exist mathematically exist also physically, by which we mean that in those complex enough to contain self-aware substructures (SASs), these SASs will subjectively perceive themselves as existing in a physically “real” world. We find that it is far from clear that this simple theory, which has no free parameters whatsoever, is observationally ruled out. The predictions of the theory take the form of probability distributions for the outcome of experiments, which makes it testable. In addition, it may be possible to rule it out by comparing its *a priori* predictions for the observable attributes of nature (the particle masses, the dimensionality of spacetime, etc.) with what is observed.

I. INTRODUCTION

Perhaps the ultimate hope for physicists is that we will one day discover what is jocularly referred to as a *TOE*, a “Theory of Everything”, an all-embracing and self-consistent physical theory that summarizes everything that there is to know about the workings of the physical world. Almost all physicists would undoubtedly agree that such a theory is still conspicuous with its absence, although the agreement is probably poorer on the issue of what would qualify as a TOE. Although the requirements that

- it should be a self-consistent theory encompassing quantum field theory and general relativity as special cases and
- it should have predictive power so as to be falsifiable in Popper’s sense

are hardly controversial, it is far from clear which of our experimental results we should expect it to predict with certainty and which it should predict only in a statistical sense. For instance, should we expect it to predict the masses of the elementary particles (measured in dimensionless Planck units, say) from first principles, are these masses free parameters in the theory, or do they arise from some symmetry-breaking process that can produce a number of distinct outcomes so that the TOE for all practical purposes merely predicts a probability distribution [1–5]?

A. A classification of TOEs

Let us divide TOEs into two categories depending on their answer to the following question: Is the physical world purely mathematical, or is mathematics merely a useful tool that approximately describes certain aspects of the physical world? More formally, *is the physical world isomorphic to some mathematical structure?* For instance, if it were not for quantum phenomena and the problem of describing matter in classical theories, a tenable TOE in the first category would be one stating that the physical world was isomorphic to a 3+1-dimensional pseudo-Riemannian manifold, on which a number of tensor fields were defined and obeyed a certain system of partial differential equations. Thus the broad picture in a category 1 TOE is this:

- There are one or more mathematical structures that exist not only in the mathematical sense, but in a physical sense as well.
- Self-aware substructures (SASs) might inhabit some of these structures, and we humans are examples of such SASs.

In other words, some subset of all mathematical structures (see Figure 1 for examples) is endowed with an elusive quality that we call physical existence, or *PE* for brevity. Specifying this subset thus specifies a category 1 TOE. Since there are three disjoint possibilities (none, some or all mathematical structures have PE), we obtain the following classification scheme:

1. The physical world is completely mathematical.
 - (a) Everything that exists mathematically exists physically.
 - (b) Some things that exist mathematically exist physically, others do not.
 - (c) Nothing that exists mathematically exists physically.
2. The physical world is not completely mathematical.

The beliefs of most physicists probably fall into categories 2 (for instance on religious grounds) and 1b. Category 2 TOEs are somewhat of a resignation in the sense of giving up physical predictive power, and will not be further discussed here. The obviously ruled out category 1c TOE was only included for completeness. TOEs in the popular category 1b are vulnerable to the criticism (made e.g. by Wheeler [6], Nozick [7] and Weinberg [8]) that they leave an important question unanswered: why is that particular subset endowed with PE, not another?

What breaks the symmetry between mathematical structures that would a priori appear to have equal merit? For instance, take the above-mentioned category 1b TOE of classical general relativity. Then why should one set of initial conditions have PE when other similar ones do not? Why should the mathematical structure where the electron/proton mass ratio $m_p/m_e \approx 1836$ have PE when the one with $m_p/m_e = 1996$ does not? And why should a 3+1-dimensional manifold have PE when a 17+5-dimensional one does not? In summary, although a category 1b TOE may one day turn out to be correct, it may come to appear somewhat arbitrary and thus perhaps disappointing to scientists hoping for a TOE that elegantly answers all outstanding questions and leaves no doubt that it really is the ultimate TOE.

In this paper, we propose that category 1a is the correct one. This is akin to what has been termed “*the principle of fecundity*” [7], that all logically acceptable worlds exist, although as will become clear in the discussion of purely formal mathematical structures in Section II, the 1a TOE involves no difficult-to-define vestige of human language such as “logically acceptable” in its definition. 1a can also be viewed as a form of radical Platonism, asserting that the mathematical structures in Plato’s *realm of ideas*, the *Mindscape* of Rucker [9], exist “out there” in a physical sense [10], akin to what Barrow refers to as “pi in the sky” [11,12].

Since 1a is (as 1c) a completely specified theory, involving no free parameters whatsoever, it is in fact a candidate for a TOE. Although it may at first appear as though 1a is just as obviously ruled out by experience as 1c, we will argue that this is in fact far from clear.

B. How to make predictions using this theory

How does one make quantitative predictions using the 1a TOE? In *any* theory, we can make quantitative predictions in the form of probability distributions by using Bayesian statistics¹. For instance, to predict the classical period T of a Foucault pendulum, we would use the equation

$$T = 2\pi\sqrt{\frac{L}{g}}. \quad (1)$$

Using probability distributions to model the errors in our measurements of the length L and the local gravitational acceleration g , we readily compute the probability distribution for T . Usually we only care about the mean $\langle T \rangle$ and the standard deviation ΔT (“the error bars”), and as long as $\Delta T/T \ll 1$, we get the mean by inserting

¹ In the Bayesian view, probabilities are merely subjective quantities, like odds, useful for making predictions.

the means in equation (1) and $\Delta T/T$ from the standard expression for the propagation of errors. In addition to the propagated uncertainty in the prior observations, the nature of the mathematical structure itself might add some uncertainty, as is the case in quantum mechanics. In the language of the previous section, both of these sources of uncertainty reflect our lack of knowledge as to which of the many SASs in the mathematical structure corresponds to the one making the experiment: imperfect knowledge of field quantities (like g) corresponds to uncertainty as to where in the spacetime manifold one is, and quantum uncertainty stems from lack of knowledge as to which branch of the wavefunction one is in (after the measurement).

In the 1a TOE, there is a third source of uncertainty as well: we do not know exactly which mathematical structure we are part of, i.e., where we are in a hypothetical expansion of Figure 1 containing all structures. Clearly, we can eliminate many options as inconsistent with our observations (indeed, many can of course be eliminated *a priori* as “dead worlds” containing no SASs at all — for instance, all structures in Figure 1 are presumably too simple to contain SASs). If we could examine all of them, and some set of mathematical structures remained as candidates, then they would each make a prediction for the form of equation (1), leaving us with a probability distribution as to which equation to use. Including this uncertainty in the probability calculation would then give us our predicted mean and error bars.

Although this prescription may sound unfamiliar, it is quite analogous to what we do all the time. We usually imagine that the fine structure constant α has some definite value in the mathematical structure that describes our world (or at least a value where the fundamental uncertainty is substantially smaller than the measurement errors in our current best estimate, $1/137.0359895$). To reflect our measurement errors on α , we therefore calculate error bars as if there were an entire ensemble of possible theories, spanning a small range of α -values. Indeed, this Bayesian procedure has already been applied to ensembles of theories with radically different values of physical constants [4,13]. According to the 1a TOE, we must go further and include our uncertainty about other aspects of the mathematical structure as well, for instance, uncertainty as to which equations to use. However, this is also little different from what we do anyway, when searching for alternative models.

C. So what is new?

Since the above prescription was found to be so similar to the conventional one, we must address the following question: can the 1a TOE be distinguished from the others in practice, or is this entire discussion merely a useless metaphysical digression?

As discussed above, the task of any theory is to com-

pute probability distributions for the outcomes of future experiments given our previous observations. Since the correspondence between the mathematical structure and everyday concepts such as “experiment” and “outcome” can be quite subtle (as will be discussed at length in Section III), it is more appropriate to rephrase this as follows: Given the subjective perceptions of a SAS, a theory should allow us to compute probability distributions for (at least certain quantitative aspects of) its future perceptions. Since this calculation involves summing over *all* mathematical structures, the 1a TOE makes the following two predictions that distinguish it from the others categories:

- **Prediction 1:** The mathematical structure describing our world is the most generic one that is consistent with our observations.
- **Prediction 2:** Our observations are the most generic ones that are consistent with our existence.

In both cases, we are referring to the totality of all observations that we have made so far in our life. The nature of the set of all mathematical structures (over which we need some form of measure to formalize what we mean by generic) will be discussed at length in Section II.

These two predictions are of quite different character. The first one offers both a useful guide when searching for the ultimate structure (if the 1a TOE is correct) and a way of predicting experimental results to potentially rule out the 1a TOE, as described in Section III. The second one is not practically useful, but provides many additional ways of potentially ruling the theory out. For instance, the structure labeled “general relativity” in Figure 1 contains the rather arbitrary number 3 as the dimensionality of space. Since manifolds of arbitrarily high dimensionality constitute equally consistent mathematical structures, a 3-dimensional one is far from “generic” and would have measure zero in this family of structures. The observation that our space appears three-dimensional would therefore rule out the 1a TOE if the alternatives were not inconsistent with the very existence of SASs. Intriguingly, as discussed in Section IV, all higher dimensionalities *do* appear to be inconsistent with the existence of SASs, since among other things, they preclude stable atoms.

D. Is this related to the anthropic principle?

Yes, marginally: the weak anthropic principle must be taken into account when trying to rule the theory out based on prediction 2.

Prediction 2 implies that the 1a TOE is ruled out if there is anything about the observed Universe that is surprising, given that we exist. So is it ruled out? For instance, the author has no right to be surprised about facts

that *a priori* would seem unlikely, such as that his grandparents happened to meet or that the spermatozoid carrying half of his genetic makeup happened to come first in a race against millions of others, as long as these facts are necessary for his existence. Likewise, we humans have no right to be surprised that the coupling constant of the strong interaction, α_s , is not 4% larger than it is, for if it were, the sun would immediately explode (the diproton would have a bound state, which would increase the solar luminosity by a factor 10^{18} [14]). This rather tautological (but often overlooked) statement that we have no right to be surprised about things necessary for our existence has been termed *the weak anthropic principle* [15]. In fact, investigation of the effects of varying physical parameters has gradually revealed that [16–18]

- *virtually no physical parameters can be changed by large amounts without causing radical qualitative changes to the physical world.*

In other words, the “island” in parameter space that supports human life appears to be quite small. This smallness is an embarrassment for TOEs in category 1b, since such TOEs provide no answer to the pressing question of why the mathematical structures possessing PE happen to belong to that tiny island, and has been hailed as support for religion-based TOEs in category 2. Such “design arguments” [17] stating that the world was designed by a divine creator so as to contain SASs are closely related to what is termed the *strong anthropic principle* [15], which states that the Universe must support life. The smallness of the island has also been used to argue in favor of various ensemble theories in category 1b, since if structures with PE cover a large region of parameter space, it is not surprising if they happen to cover the island as well. The same argument of course supports our 1a TOE as well, since it in fact predicts that structures on this island (as well as all others) have PE.

In conclusion, when comparing the merits of TOE 1a and the others, it is important to calculate which aspects of the physical world are necessary for the existence of SASs and which are not. Any clearly demonstrated feature of “fine tuning” which is unnecessary for the existence of SASs would immediately rule out the 1a TOE. For this reason, we will devote Section IV to exploring the “local neighborhood” of mathematical structures, to see by how much our physical world can be changed without becoming uninhabitable.

E. How this paper is organized

The remainder of this paper is organized as follows. Section II discusses which structures exist mathematically, which defines the grand ensemble of which our world is assumed to be a member. Section III discusses how to make physical predictions using the 1a TOE. It comments on the subtle question of how mathematical

structures are perceived by SASs in them, and proposes criteria that mathematical structures should satisfy in order to be able to contain SASs. Section IV uses the three proposed criteria to map out our local island of habitability, discussing the effects of varying physical constants, the dimensionality of space and time, etc. Finally, our conclusions are summarized in section V.

II. MATHEMATICAL STRUCTURES

Our proposed TOE can be summarized as follows:

- *Physical existence is equivalent to mathematical existence.*²

What precisely is meant by mathematical existence, or *ME* for brevity? A generally accepted interpretation of ME is that of David Hilbert:

- *Mathematical existence is merely freedom from contradiction.*

In other words, if the set of axioms that define a mathematical structure cannot be used to prove both a statement and its negation, then the mathematical structure is said to have ME.

The purpose of this section is to remind the non-mathematician reader of the purely formal foundations of mathematics, clarifying how extensive (and limited) the “ultimate ensemble” of physical worlds really is, thereby placing Nozick’s notion [7] of “all logically acceptable worlds” on a more rigorous footing. The discussion is centered around Figure 1. By giving examples, we will illustrate the following points:

- The notion of a mathematical structure is well-defined.
- Although a rich variety of structures enjoy mathematical existence, the variety is limited by the requirement of self-consistency and by the identification of isomorphic ones.
- Mathematical structures are “emergent concepts” in a sense resembling that in which physical structures (say classical macroscopic objects) are emergent concepts in physics.

² Tipler has postulated that what he calls a *simulation* (which is similar to what we call a mathematical structure) has PE if and only if it contains at least one SAS [21]. From our operational definition of PE (that a mathematical structure has PE if all SASs in it subjectively perceive themselves as existing in a physically real sense), it follows that the difference between this postulate and ours is merely semantical.

- It appears likely that the most basic mathematical structures that we humans have uncovered to date are the same as those that other SASs would find.
- Symmetries and invariance properties are more the rule than the exception in mathematical structures.

A. Formal systems

For a more rigorous and detailed introduction to formal systems, the interested reader is referred to pedagogical books on the subject such as [19,20].

The mathematics that we are all taught in school is an example of a formal system, albeit usually with rather sloppy notation. To a logician, a *formal system* consists of

- A collection of symbols (like for instance “ \sim ”, “ \mapsto ” and “ X ”) which can be strung together into strings (like “ $\sim\sim X \mapsto X$ ” and “ $XXXXX$ ”)
- A set of rules for determining which such strings are *well-formed formulas*, abbreviated WFFs and pronounced “woofs” by logicians
- A set of rules for determining which WFFs are *theorems*

B. Boolean algebra

The formal system known as *Boolean algebra* can be defined using the symbols “ \sim ”, “ \vee ”, “[”, “]” and a number of letters “ x ”, “ y ”, ... (these letters are referred to as *variables*). The set of rules for determining what is a WFF are recursive:

- A single variable is a WFF.
- If the strings S and T are WFFs, then the strings $[\sim S]$ and $[S \vee T]$ are both WFFs.

Finally, the rules for determining what is a theorem consist of two parts: a list of WFFs which are stated to be theorems (the WFFs on this list are called *axioms*), and rules of inference for deriving further theorems from the axioms. The axioms are the following:

1. $[[x \vee x] \mapsto x]$
2. $[x \mapsto [x \vee y]]$
3. $[[x \vee y] \mapsto [y \vee x]]$
4. $[[x \mapsto y] \mapsto [[z \vee x] \mapsto [z \vee y]]]$

The symbol “ \mapsto ” appearing here is not part of the formal system. The string “ $x \mapsto y$ ” is merely a convenient abbreviation for “ $[\sim x] \vee y$ ”. The rules of inference are

- The *rule of substitution*: if the string S is a WFF and the string T is a theorem containing a variable, then the string obtained by replacing this variable by S is a theorem.
- *Modus ponens*: if the string $[S \mapsto T]$ is a theorem and S is a theorem, then T is a theorem.

Two additional convenient abbreviations are “ $x&y$ ” (defined as “ $\sim [[\sim x] \vee [\sim y]]$ ” and “ $x \equiv y$ ” (defined as “ $[x \mapsto y] \& [y \mapsto x]$ ”). Although customarily pronounced “not”, “or”, “and”, “implies” and “is equivalent to”, the symbols \sim , \vee , $\&$, \mapsto and \equiv have no meaning whatever assigned to them — rather, any “meaning” that we chose to associate with them is an emergent concept stemming from the axioms and rules of inference.

Using nothing but these rules, all theorems in Boolean algebra textbooks can be derived, from simple strings such as “ $[x \vee [\sim x]]$ ” to arbitrarily long strings.

The formal system of Boolean algebra has a number of properties that gives it a special status among the infinitely many other formal systems. It is well-known that Boolean algebra is *complete*, which means that given an arbitrary WFF S , either S is provable or its negation, $[\sim S]$ is provable. If any of the four axioms above were removed, the system would no longer be complete in this sense. This means that if an additional axiom S is added, it must either be provable from the other axioms (and hence unnecessary) or inconsistent with the other axioms. Moreover, it can be shown that “ $[[x \& [\sim x]] \mapsto y]$ ” is a theorem, i.e., that if both a WFF and its negation is provable, then *every WFF becomes provable*. Thus adding an independent (non-provable) axiom to a complete set of axioms will reduce the entire formal system to a banality, equivalent to the trivial formal system defined by “all WFFs are theorems”³. Thus the formal system of Boolean algebra is not as arbitrary as it may at first seem. In fact, it is so basic that almost all formal systems deemed complex enough by mathematicians to warrant their study are obtained by starting with Boolean algebra and augmenting it with further symbols and axioms.⁴ For this reason, it appears at the bottom of the “tree” of structures in Figure 1.

³ Our definition of a mathematical structure having PE was that if it contained a SAS, then this SAS would subjectively perceive itself as existing. This means that Hilbert’s definition of mathematical existence as self-consistency does not matter for our purposes, since inconsistent systems are too trivial to contain SASs anyway. Likewise, endowing “equal rights” to PE to formal systems below Boolean algebra, where negation is not even defined and Hilbert’s criterion thus cannot be applied, would appear to make no difference, since these formal systems seem to be far too simple to contain SASs.

⁴As we saw, adding more axioms to Boolean algebra without adding new symbols is a losing proposition.

C. What we mean by a mathematical structure

The above-mentioned example of Boolean algebra illustrates several important points about formal systems in general. No matter how many (consistent) axioms are added to a complete formal system, the set of theorems remains the same. Moreover, there are in general a large number of different choices of independent axioms that are equivalent in the sense that they lead to the same set of theorems, and a systematic attempt to reduce the theorems to as few independent axioms as possible would recover all of these choices independently of which one was used as a starting point. Continuing our Boolean algebra example, upgrading $\&$, \mapsto and \equiv to fundamental symbols and adding additional axioms, one can again obtain a formal system where the set of theorems remains the same. Conversely, as discovered by Sheffer, an equivalent formal system can be obtained with even fewer symbols, by introducing a symbol “|” and demoting “ $\sim x$ ” and “ $x \vee y$ ” to mere abbreviations for “ $x|x$ ” and “ $[x|x][|y|y]$ ”, respectively. Also, the exact choice of notation is of course completely immaterial — a formal system with “%” in place of “ \mapsto ” or with the bracket system eliminated by means of reverse Polish notation would obviously be isomorphic and thus for mathematical purposes one and the same. In summary, although there are many different ways of describing the mathematical structure known as Boolean algebra, they are in a well-defined sense all equivalent. The same can be said about all other mathematical structures that we will be discussing. All formal systems can thus be subdivided into a set of disjoint equivalence classes, such that the systems in each class all describe the same structure. When we speak of a mathematical structure, we will mean such an equivalence class, i.e., *that structure which is independent of our way of describing it*. It is to this structure that our 1a TOE attributes physical existence.

D. “Mathematics space” and its limits

If all mathematical structures have PE, then it is clearly desirable to have a crude overview of what mathematical structures there are. Figure 1 is by no means such a complete overview. Rather, it contains a selection of structures (solid rectangles), roughly based on the Mathematics Subject Classification of the American Mathematical Society. They have been ordered so that following an arrow corresponds to adding additional symbols and/or axioms. We will now discuss some features of this “tree” or “web” that are relevant to the 1a TOE, illustrated by examples.

1. Lower predicate calculus and beyond

We will not describe the WFF rules for the formal systems mentioned below, since the reader is certainly familiar with notation such as that for parentheses, variables and quantifiers, as well as with the various conventions for when parentheses and brackets can be omitted. For instance, within the formal system of number theory described below, a logician would read

$$P(n) \equiv [(\forall a)(\forall b)[[a > 1] \& [b > 1] \mapsto a \cdot b \neq n]] \quad (2)$$

as $P(n)$ being the statement that the natural number n is prime, i.e., that for all natural numbers a and b exceeding unity, $a \cdot b \neq n$, and

$$[a > 0][(\exists b)(\exists c)[P(b) \& P(c) \& [a + a = b + c]] \quad (3)$$

as the (still unproven) Goldbach hypothesis that all even numbers can be written as the sum of two primes. (Again, we emphasize that despite that we conventionally read them this way, the symbols of a formal system have no meaning whatsoever — the properties that we humans coin words for merely emerge from the axioms and rules of inference.)

Moving upward in Figure 1, the formal system known as *Lower Predicate Calculus* is obtained from Boolean Algebra by adding quantifiers (\forall and \exists). One way of doing this is to add the axioms

1. $[(\forall a)[A(a)]] \mapsto A(b)$
2. $[(\forall a)[A \vee B(a)]] \mapsto [A \vee [(\forall a)B(a)]]$

and the rule that if $A(a)$ is a theorem involving no quantifiers for a , then $(\forall a)[A(a)]$ is a theorem — $(\exists a)[A(a)]$ can then be taken as a mere abbreviation for $\sim (\forall a)[\sim A(a)]$.

Virtually all mathematical structures above lower predicate calculus in Figure 1 involve the notion of *equality*. The relation $a = b$ (sometimes written as $E(a, b)$ instead) obeys the so called axioms of equality:

1. $a = a$
2. $a = b \mapsto b = a$
3. $[a = b] \& [b = c] \mapsto a = c$
4. $a = b \mapsto [A(a) \mapsto A(b)]$

The first three (reflexivity, symmetry and transitivity) make “=” a so-called equivalence relation, and the last one is known as the condition of substitutivity.

Continuing upward in Figure 1, the formal system known as *Number Theory* (the natural numbers under addition and multiplication) can be obtained from Lower Predicate Calculus by adding the five symbols “=”, “0”, “/”, “+” and “·”, the axioms of equality, and the following axioms [19]:

1. $\sim [a' = 0]$
2. $[a' = b'] \mapsto [a = b]$
3. $a + 0 = a$
4. $a + b' = (a + b)'$
5. $a \cdot 0 = 0$
6. $a \cdot b' = a \cdot b + a$
7. $[A(0) \& [(\forall a)[A(a) \mapsto A(a')]]] \mapsto A(b)$

Convenient symbols like 1, 2, “ \neq ”, “ $<$ ”, “ $>$ ”, “ \leq ” and “ \geq ” can then be introduced as mere abbreviations — 1 as an abbreviation for $0'$, 2 as an abbreviation for $0''$, “ $a \leq b$ ” as an abbreviation for “ $(\exists c)[a + c = b]$ ”, etc. This formal system is already complex enough to be able to “talk about itself”, which formally means that Gödel’s incompleteness theorem applies: there are WFFs such that neither they nor their negations can be proven.

Alternatively, adding other familiar axioms leads to other branches in Figure 1.

A slightly unusual position in the mathematical family tree is that labeled by “models” in the figure. Model theory (see e.g. [22]) studies the relationship between formal systems and set-theoretical models of them in terms of sets of objects and relations that hold between these objects. For instance, the set of real numbers constitute a model for the field axioms. In the 1a TOE, all mathematical structures have PE, so set-theoretical models of a formal system enjoy the same PE that the formal system itself does.

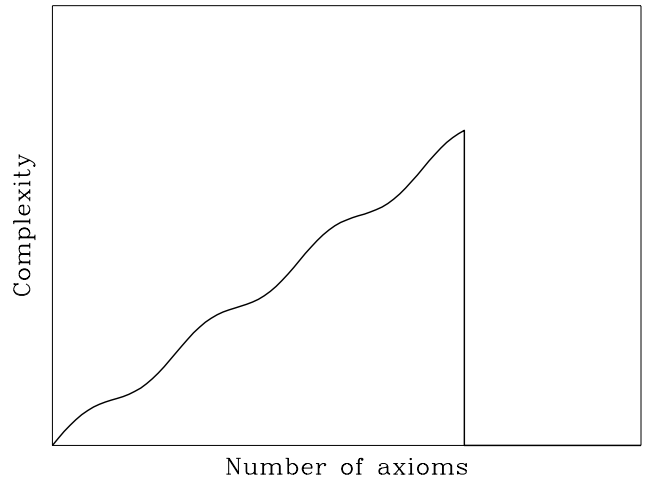

FIG. 2. With too few axioms, a mathematical structure is too simple to contain SASs. With too many, it becomes inconsistent and thus trivial.

2. The limits of variety

The variety of mathematical structures, a small part of which is illustrated in Figure 1, is limited in two ways.

First of all, they are much fewer than the formal systems, since they are equivalence classes as described in Section II C. For instance, natural numbers (under $+$ and \cdot) are a single mathematical structure, even though there are numerous equivalent ways of axiomatizing the formal system of number theory.

Second, the self-consistency requirement adds a natural cutoff as one tries to proceed too far along arrows in Figure 1. If one keeps adding axioms in the attempt to create a more complex structure, the bubble eventually bursts, as schematically illustrated in Figure 2. For instance, consider the progression from semi-groups to groups to finite groups to the specific case of the dodecahedron group (a dashed rectangle in Figure 1), where each successive addition of axioms has made the structure less general and more specific. Since the entire multiplication table of the dodecahedron group is specified, any attempt to make the dodecahedron still more “specific” will make the formal system inconsistent, reducing it to the banal one where all WWF’s are theorems.

Figure 1 also illustrates a more subtle occurrence of such a “complexity cutoff”, where even adding new symbols does not prevent a branch of the tree from ending. Since a field is in a sense a double group (a group under the 1st binary operation, and after removing its identity, also a group under the 2nd), it might seem natural to explore analogous triple groups, quadruple groups, etc. In Figure 1, these structures are labeled “double fields” and “triple fields”, respectively. A double field D has 3 binary operations, say Δ , $+$ and \cdot , having identities that we will denote ∞ , 0 and 1 , respectively, such that D under Δ and $+$, and D without ∞ under $+$ and \cdot are both fields. A triple field is defined analogously. For simplicity, we will limit ourselves to ones with a finite number of elements. Whereas there is a rich and infinite variety of finite fields (Galois Fields), it can be shown [23] that (apart from a rather trivial one with 3 elements), there is only one double field per Mersenne prime (primes of the form $2^n - 1$), and it is not known whether there are infinitely many Mersenne primes. As to finite triple fields, it can be shown [23] that there are none at all, i.e., that particular mathematical structure in Figure 1 is inconsistent and hence trivial.

An analogous case of a “terminating branch” is found by trying to extend the ladder of Abelian fields beyond the sequence rational, real and complex numbers. By appropriately defining $=$, $+$ and \cdot for quadruples (rather than pairs) of real numbers, one obtains the field of quaternions, also known as $SU(2)$. However, the Abelian property has been lost. Repeating the same idea for larger sets of real numbers gives matrices, which do not even form a field (since the sum of two invertible matrices can be non-invertible).

E. The sense in which mathematical structures are an emergent concept

Suppose a SAS were given the rules of some formal system and asked to compile a catalog of theorems (for the present argument, it is immaterial whether the SAS is a carbon-based life-form like ourselves, a sophisticated computer program or something completely different). One can then argue that [24] it would eventually invent additional notation and branches of mathematics beyond this particular formal system, simply as a means of performing its task more efficiently. As a specific example, suppose that the formal system is Boolean algebra as we defined it in Section II B, and that the SAS tries to make a list of all strings shorter than some prescribed length which are theorems (the reader is encouraged to try this). After blindly applying the rules of inference for a while, it would begin to recognize certain patterns and realize that it could save considerable amounts of effort by introducing convenient notation reflecting these patterns. For instance, it would with virtual certainty introduce some notation corresponding to “ $\sim [[\sim x] \vee [\sim y]]$ ” (for which we used the abbreviation “ \dashv ”) at some point, as well as notation corresponding what we called “ $\&$ ” and “ \equiv ”. If as a starting point we had given the SAS the above-mentioned Sheffer version of Boolean algebra instead, it would surely have invented notation corresponding to “ \sim ” and \vee as well. How much notation would it invent? A borderline case would be something like writing “ $x \leftarrow y$ ” as an “abbreviation” for “ $y \mapsto x$ ”, since although the symbol “ \leftarrow ” is arguably helpful, its usefulness is so marginal that it is unclear whether it is worth introducing it at all — indeed, most logic textbooks do not.

After some time, the SAS would probably discover that its task could be entirely automated by inventing the concept of truth tables, where “ $[x \vee [\sim x]]$ ” and its negation play the roles of what we call “true” and “false”. Furthermore, when it was investigating WWFs containing long strings of negations, e.g., “ $\sim\sim\sim\sim\sim\sim [x \vee [\sim x]]$ ”, it might find it handy to introduce the notion of counting and of even and odd numbers.

To further emphasize the same point, if we gave the SAS as a starting point the more complex formal system of number theory discussed above, it might eventually rediscover a large part of mathematics as we know it to aid it in proving theorems about the natural numbers. As is well known, certain theorems about integers are most easily proven by employing methods that use more advanced concepts such as real numbers, analytic functions, etc. Perhaps the most striking such example to date is the recent proof of Fermat’s last theorem, which employs state-of-the-art methods of algebraic geometry (involving, e.g., semistable elliptic curves) despite the fact that the theorem itself can be phrased using merely integers.

F. What structures have we missed?

Conversely, the systematic study of virtually any more complicated mathematical structure that did not explicitly involve say integers would lead a SAS to reinvent the integers, since they are virtually ubiquitous. The same could be said about most other basic mathematical structures, e.g., groups, algebras and vector spaces. Just as it was said that “*all roads lead to Rome*”, we are thus arguing that “*all roads lead to the integers*” and other basic structures — which we therefore refer to as “emergent concepts”.

If this point of view is accepted, then an immediate conclusion is that all types of SASs would arrive at similar descriptions of the “mathematics tree”. Thus although one would obviously expect a certain bias towards being more interested in mathematics that appears relevant to physics, i.e., to the particular structure in which the SAS resides, it would appear unlikely that any form of SASs would fail to discover basic structures such as say Boolean Algebra, integers and complex numbers. In other words, it would appear unlikely that we humans have overlooked any equally basic mathematical structures.

G. Why symmetries and ensembles are natural

Above we saw that a general feature of formal systems is that all elements in a set are “born equal” – further axioms are needed to discriminate between them. This means that symmetry and invariance properties tend to be more the rule than the exception in mathematical structures. For instance, a three-dimensional vector space automatically has what a physicist would call rotational symmetry, since no preferred direction appears in its definition. Similarly, any theory of physics involving the notion of a manifold will automatically exhibit invariance under general coordinate transformations, simply because the very definition of a manifold implies that no coordinate systems are privileged over any other.

Above we also saw that the smaller one wishes the ensemble to be, the more axioms are needed. Defining a highly specific mathematical structure with built-in dimensionless numbers such as $1/137.0359895$ is far from trivial. Indeed, it is easy to prove that merely a denumerable subset of all real numbers (a subset of measure zero) can be specified by a finite number of axioms⁵, so

⁵ The proof is as follows. Each such number can be specified by a LATEX file of finite length that gives the appropriate axioms in some appropriate notation. Since each finite LATEX file can be viewed as a single integer (interpreting all its bits as as binary decimals), there are no more finite LATEX files than there are integers. Therefore there are only countably many such files and only countably many real numbers that

writing down a formal system describing a 1b TOE with built-in “free parameters” would be difficult unless these dimensionless numbers could all be specified “numerologically”, as Eddington once hoped.

III. HOW TO MAKE PHYSICAL PREDICTIONS FROM THE THEORY

How does one use the Category 1a TOE to make physical predictions? Might it really be possible that a TOE whose specification contains virtually no information can nonetheless make predictions such as that we will perceive ourselves as living in a space with three dimensions, etc.? Heretic as it may sound, we will argue that yes, this might really be possible, and outline a program for how this could be done. Roughly speaking, this involves examining which mathematical structures might contain SASs, and calculating what these would subjectively appear like to the SASs that inhabit them. By requiring that this subjective appearance be consistent with all our observations, we obtain a list of structures that are candidates for being the one we inhabit. The final result is a probability distribution for what we should expect to perceive when we make an experiment, using Bayesian statistics to incorporate our lack of knowledge as to precisely which mathematical structure we reside in.

A. The inside view and the outside view

A key issue is to understand the relationship between two different ways of perceiving a mathematical structure. On one hand, there is what we will call the “*view from outside*”, or the “*bird perspective*”, which is the way in which a mathematician views it. On the other hand, there is what we will call the “*view from inside*”, or the “*frog perspective*”, which is the way it appears to a SAS in it. Let us illustrate this distinction with a few examples:

1. Classical celestial mechanics

Here the distinction is so slight that it is easy to overlook it altogether. The outside view is that of a set of vector-valued functions of one variable, $\mathbf{r}_i(t) \in \mathbf{R}^3$, $i = 1, 2, \dots$, obeying a set of coupled nonlinear second order ordinary differential equations. The inside view is that of a number of objects (say planets and stars) at

can be specified “numerologically”, i.e., by a finite number of axioms. In short, the set of real numbers that we can specify at all ($\sqrt{2}$, π , the root of $x^7 - e^x$, etc.) has Lebesgue measure zero.

locations \mathbf{r} in a three-dimensional space, whose positions are changing with time.

2. Electrodynamics in special relativity

Here one choice of outside view is that of a set of real-valued functions $F_{\mu\nu}$ and J_μ in \mathbf{R}^4 which obey a certain system of Lorentz-invariant linear partial differential equations; the Maxwell equations and the equation of motion $(J_{\mu,\nu} - F_{\mu\nu})J^\nu = 0$. The correspondence between this and the inside view is much more subtle than in the above example, involving a number of notions that may seem counter-intuitive. Arguably, the greatest difficulty in formulating this theory was not in finding the mathematical structure but in interpreting it. Indeed, the correct equations had to a large extent already been written down by Lorentz and others, but it took Albert Einstein to explain how to relate these mathematical objects to what we SASs actually perceive, for instance by pointing out that the inside view in fact depended not only on the position of the SAS but also on the velocity of the SAS. A second bold idea was the notion that although the bird perspective is that of a four-dimensional world that just is, where nothing ever happens, it will appear from the frog perspective as a three-dimensional world that keeps changing.

3. General relativity

Here history repeated itself: although the mathematics of the outside view had largely been developed by others (e.g., Minkowski and Riemann), it took the genius of Einstein to relate this to the subjective experience from the frog perspective of a SAS. As an illustration of the difficulty of relating the inside and outside views, consider the following scenario. On the eve of his death, Newton was approached by a genie who granted him one last wish. After some contemplation, he made up his mind: *“Please tell me what the state-of-the-art equations of gravity will be in 300 years.”*

The genie scribbled down the Einstein field equations and the geodesic equation on a sheet of paper, and being a kind genie, it also gave the explicit expressions for the Christoffel symbols and the Einstein tensor in terms of the metric and explained to Newton how to translate the index and comma notation into his own mathematical notation. Would it be obvious to Newton how to interpret this as a generalization of his own theory?

4. Nonrelativistic quantum mechanics

Here the difficulty of relating the two viewpoints reached a new record high, manifested in the fact that physicists still argue about how to interpret the theory

today, 70 years after its inception. Here one choice of outside view is that of a Hilbert space where a wave function evolves deterministically, whereas the inside view is that of a world where things happen seemingly at random, with probability distributions that can be computed to great accuracy from the wave function. It took over 30 years from the birth of quantum mechanics until Everett [25] showed how the inside view could be related with this outside view. Discovering decoherence, which was crucial for reconciling the presence of macrosuperpositions in the bird perspective with their absence in the frog perspective, came more than a decade later [26]. Indeed, some physicists still find this correspondence so subtle that they prefer the Copenhagen interpretation with a Category 2 TOE where there is no outside view at all.

5. Quantum gravity

Based on the above progression of examples, one would naturally expect the correct theory of quantum gravity to pose even more difficult interpretational problems, since it must incorporate all of the above as special cases. A recent review [27] poses the following pertinent question: *is the central problem of quantum gravity one of physics, mathematics or philosophy?* Suppose that on the eve of the next large quantum gravity meeting, our friend the genie broke into the lecture hall and scribbled the equations of the ultimate theory on the blackboard. Would any of the participants realize what was being erased the next morning?

B. Computing probabilities

Let us now introduce some notation corresponding to these two viewpoints.

1. Locations and perceptions

Let X denote what a certain SAS subjectively perceives at a given instant. To be able to predict X , we need to specify three things:

- Which mathematical structure this SAS is part of
- Which of the many SASs in this structure is this one
- Which instant (according to the time perception of the SAS) we are considering.

We will label the mathematical structures by i , the SASs in structure i by j and the subjective time of SAS (i, j) by t — this is a purely formal labeling, and our use of sums below in no way implies that these quantities are discrete or even denumerably infinite. We will refer to the set of all three quantities, $L \equiv (i, j, t)$, as a *location*. If the

world is purely mathematical so that a TOE in category 1 is correct, then specifying the location of a perception is in principle sufficient to calculate what the perception will be. Although such a calculation is obviously not easy, as we will return to below, let us for the moment ignore this purely technical difficulty and investigate how predictions can be made.

2. Making predictions

Suppose that a SAS at location L_0 has perceived Y up until that instant, and that this SAS is interested in predicting the perception X that it will have a subjective time interval Δt into the future, at location L_1 . The SAS clearly has no way of knowing *a priori* what the locations L_0 and L_1 are (all it knows is Y , what it has perceived), so it must use statistics to reflect this uncertainty. A well-known law of probability theory tells us that for any mutually exclusive and collectively exhaustive set of possibilities B_i , the probability of an event A is given by $P(A) = \sum_i P(A|B_i)P(B_i)$. Using this twice, we find that the probability of X given Y is

$$P(X|Y) = \sum_{L_0} \sum_{L_1} P(X|L_1)P(L_1|L_0)P(L_0|Y). \quad (4)$$

Since a SAS is by definition only in a single mathematical structure i and since $t_1 = t_0 + \Delta t$, the second factor will clearly be of the form

$$P(L_1|L_0) = P(i_1, j_1, t_1|i_0, j_0, t_0) = \delta_{i_0 i_1} \delta(t_1 - t_0 - \Delta t) P(j_1|i_0, j_0). \quad (5)$$

If, in addition, there is a 1-1 correspondence between the SASs at t_0 and t_1 , then we would have simply $P(j_1|i_0, j_0) = \delta_{j_1 j_2}$. Although this is the case in, for instance, classical general relativity, this is not the case in universally valid quantum mechanics, as schematically illustrated in Figure 3. As to the third factor in equation (4), applying Bayes' theorem with a uniform prior for the locations gives $P(L_0|Y) \propto P(Y|L_0)$, so equation (4) reduces to

$$P(X|Y) \propto \sum_{ij_0 j_1 t} P(X|i, j_1, t + \Delta t) P(j_1|i, j_0) P(Y|i, j_0, t), \quad (6)$$

where $P(X|Y)$ should be normalized so as to be a probability distribution for X . For the simple case when $P(j_1|i_0, j_0) = \delta_{j_1 j_2}$, we see that the resulting equation

$$P(X|Y) \propto \sum_{ijt} P(X|i, j, t + \Delta t) P(Y|i, j, t) \quad (7)$$

has quite a simple interpretation. Since knowledge of a location $L = (i, j, t)$ uniquely determines the corresponding perception, the two probabilities in this expression

are either zero or unity. We have $P(X|L) = 1$ if a SAS at location L perceives X and $P(X|L) = 0$ if it does not. $P(X|Y)$ is therefore simply a sum giving weight 1 to all cases that are consistent with perceiving Y and then perceiving X a time interval Δt later, normalized so as to be a probability distribution over X . The interpretation of the more general equation (6) is analogous: the possibility of “observer branching” simply forces us to take into account that we do not with certainty know the location L_1 where X is perceived even if we know L_0 exactly.

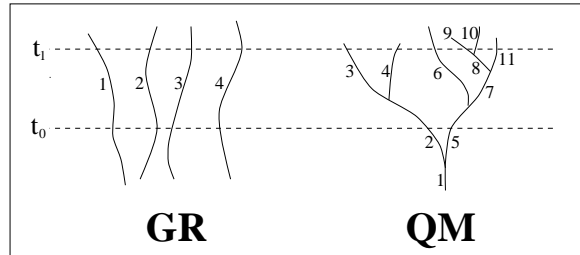

FIG. 3. Whereas there is generally a 1-1 correspondence between SASs at different times in classical general relativity (GR), “observer branching” makes the situation more complicated in quantum mechanics (QM).

3. How 1a and 1b TOEs differ

Equation (6) clarifies how the predictions from TOE 1a differ from those in 1b: whereas the sum should be extended over all mathematical structures i in the former case, it should be restricted to a certain subset (that which is postulated to have PE) in the latter case. In addition, 1b TOEs often include prescriptions for how to determine what we denote $P(X|L)$, i.e., the correspondence between the inside and outside viewpoints, the correspondence between the numbers that we measure experimentally and the objects in the mathematical structure. Such prescriptions are convenient simply because the calculation of $P(X|L)$ is so difficult. Nonetheless, it should be borne in mind that this is strictly speaking redundant information, since $P(X|L)$ can in principle be computed *a priori*.

C. Inside vs. outside: what has history taught us?

In the past, the logical development has generally been to start with our frog perspective and search for a bird perspective (a mathematical structure) consistent with it. To explore the implications of our proposed TOE using equation (6), we face the reverse problem: given the latter, what can we say about the former? Given a mathematical structure containing a SAS, what will this SAS perceive, i.e., what is $P(X|L)$? This question is clearly relevant to all TOEs in category 1, including 1b. Indeed, few would dispute that a 1b TOE would gain in elegance

if any of its postulates in the above-mentioned “prescription” category could be trimmed away with Occam’s razor by being shown to follow from the other postulates.

Perhaps the best guide in addressing this question is what we have (arguably) learned from previous successful theories. We discuss such lessons below.

1. *Do not despair*

Needless to say, the question of what a SAS would perceive in a given mathematical structure is a very difficult one, which we are far from being able to answer at the present time. Indeed, so far we have not even found a single mathematical structure that we feel confident might contain SASs, since a self-consistent model of quantum gravity remains conspicuous with its absence. Nonetheless, the successes of relativity theory and quantum mechanics have shown that we can make considerable progress even *without* having completely solved the problem, which would of course involve issues as difficult as understanding the human brain. In these theories, strong conclusions were drawn about what could and could not be perceived that were independent of any detailed assumption about the nature of the SAS. We list a few examples below.

2. *We perceive symmetry and invariance*

As SASs, we can only perceive those aspects of the mathematical structure that are independent of our notation for describing it (which is tautological, since this is all that has mathematical existence). For instance, as described in section IIG, if the mathematical structure involves a manifold, a SAS can only perceive properties that have general covariance.

3. *We perceive only that which is useful*

We seem to perceive only those aspects of the mathematical structure (and of ourselves) that are useful to perceive, i.e., which are relatively stable and predictable. Within the framework of Darwinian evolution, it would appear as though we humans have been endowed with self-awareness in the first place merely because certain aspects of our world are somewhat predictable, and since this self-awareness (our perceiving and thinking) increases our reproductive chances⁶. Self-awareness would

⁶ In the 1a TOE, where all mathematical structures exist, some SASs presumably exist anyway, without having had any evolutionary past. Nonetheless, since processes that increase the capacity of SASs to multiply will have a dramatic effect

then be merely a side-effect of advanced information processing. For instance, it is interesting to note that our bodily defense against microscopic enemies (our highly complex immune system) does not appear to be self-aware even though our defense against macroscopic enemies (our brain controlling various muscles) does. This is presumably because the aspects of our world that are relevant in the former case are so different (smaller length scales, longer time scales, etc.) that sophisticated logical thinking and the accompanying self-awareness are not particularly useful here.

Below we illustrate this usefulness criterion with three examples.

4. *Example 1: we perceive ourselves as local*

Both relativity and quantum mechanics illustrate that we perceive ourselves as being “local” even if we are not. Although in the bird perspective of general relativity, we are one-dimensional world lines in a static four-dimensional manifold, we nonetheless perceive ourselves as points in a three-dimensional world where things happen. Although a state where a person is in a superposition of two macroscopically different locations is perfectly legitimate in the bird perspective of quantum mechanics, both of these SASs will perceive themselves as being in a well-defined location in their own frog perspectives. In other words, it is only in the frog perspective that we SASs have a well-defined “local” identity at all. Likewise, we perceive objects other than ourselves as local.

5. *Example 2: we perceive ourselves as unique*

We perceive ourselves as unique and isolated systems even if we are not. Although in the bird perspective of universally valid quantum mechanics, we can end up in several macroscopically different configurations at once, intricately entangled with other systems, we perceive ourselves as remaining unique and isolated systems. What appears as “observer branching” in the bird perspective, appears as merely a slight randomness in the frog perspective. In quantum mechanics, the correspondence between these two viewpoints can be elegantly modeled with the density matrix formalism, where the approximation that we remain isolated systems corresponds to partial tracing over all external degrees of freedom.

on the various probabilities in equation (6), one might expect the vast majority of all SASs to have an evolutionary past. In other words, one might expect the generic SAS to perceive precisely those aspects the mathematical structure which are useful to perceive.

6. Example 3: we perceive that which is stable

We human beings replace the bulk of both our “hardware” (our cells, say) and our “software” (our memories, etc.) many times in our life span. Nonetheless, we perceive ourselves as stable and permanent [7]. Likewise, we perceive objects other than ourselves as permanent. Or rather, what we perceive as objects are those aspects of the world which display a certain permanence. For instance, as Eddington remarked [28], when observing the ocean we perceive the moving waves as objects because they display a certain permanence, even though the water itself is only bobbing up and down. Similarly, we only perceive those aspects of the world which are fairly stable to quantum decoherence [26].

7. There can be ensembles within the ensemble

Quantum statistical mechanics illustrates that there can be ensembles within an ensemble. A pure state can correspond to a superposition of a person being in two different cities at once, which we, because of decoherence, count as two distinct SASs, but a density matrix describing a mixed state reflects additional uncertainty as to which is the correct wave function. In general, a mathematical structure i may contain two SASs that perceive themselves as belonging to completely disjoint and unrelated worlds.

8. Shun classical prejudice

As the above discussion illustrates, the correspondence between the inside and outside viewpoints has become more subtle in each new theory (special relativity, general relativity, quantum mechanics). This means that we should expect it to be extremely subtle in a quantum gravity theory and try to break all our shackles of preconception as to what sort of mathematical structure we are looking for, or we might not even recognize the correct equations if we see them. For instance, criticizing the Everett interpretation of quantum mechanics [25] on the grounds that it is “too crazy” would reflect an impermissible bias towards the familiar classical concepts in terms of which we humans describe our frog perspective. In fact, the rival Copenhagen interpretation of quantum mechanics does not correspond to a mathematical structure at all, and therefore falls into category 2 [29,30]. Rather, it attributes *a priori* reality to the non-mathematical frog perspective (“the classical world”) and denies that there is a bird perspective at all.

D. Which structures contain SASs?

Until now, we have on purpose been quite vague as to what we mean by a SAS, to reduce the risk of tacitly assuming that it must resemble us humans. However, some operational definition is of course necessary to be able to address the question in the title of this section. Above we asked what a SAS of a given mathematical structure would perceive. A SAS definition allowing answers such as “nothing at all” or “complete chaos” would clearly be too broad. Rather, we picture a self-aware substructure as something capable of some form of logical thought. We take the property of being “self-aware” as implicitly defined: a substructure is self-aware if it thinks that it is self-aware. To be able to perceive itself as thinking (having a series of thoughts in some logical succession), it appears as though a SAS must subjectively perceive some form of time, either continuous (as we do) or discrete (as our digital computers). That it have a subjective perception of some form of space, on the other hand, appears far less crucial, and we will not require this. Nor will we insist on many of the common traits that are often listed in various definitions of life (having a metabolism, ability to reproduce, etc.), since they would tacitly imply a bias towards SASs similar to ours living in a space with atoms, having a finite lifetime, etc. As necessary conditions for containing a SAS, we will require that a mathematical structure exhibit a certain minimum of merely three qualities:

- Complexity
- Predictability
- Stability

What we operationally mean by these criteria is perhaps best clarified by the way in which we apply them to specific cases in Section IV. Below we make merely a few clarifying comments. That self-awareness is likely to require the SAS (and hence the mathematical structure of which it is a part) to possess a certain minimum *complexity* goes without saying. In this vein, Barrow has suggested that only structures complex enough for Gödel’s incompleteness theorem to apply can contain what we call SASs [12], but this is of course unlikely to be a sufficient condition. The other two criteria are only meaningful since we required SASs to subjectively experience some form of time.

By *predictability* we mean that the SAS should be able to use its thinking capacity to make certain inferences about its future perceptions. Here we include for us humans rather obvious predictions, such as that an empty desk is likely to remain empty for the next second rather than, say, turn into an elephant.

By *stability* we mean that a SAS should exist long enough (according to its own subjective time) to be able to make the above-mentioned predictions, so this is strictly speaking just a weaker version of the predictability requirement.

E. Why introduce the SAS concept?

We conclude this section with a point on terminology. The astute reader may have noticed that the various equations in this section would have looked identical if we have defined our observers as say “human beings” or “carbon-based life-forms” instead of using the more general term the “SAS”. Since our prior observations Y include the fact that we are carbon-based, etc., and since it is only Prediction 1 (mentioned in the introduction) that is practically useful, would it not be preferable to eliminate the SAS concept from the discussion altogether? This is obviously a matter of taste. We have chosen to keep the discussion as general as possible for the following reasons:

- The requirement that mathematical structures should contain SASs provides a clean way of severely restricting the number of structures to sum over in equation (6) before getting into nitty-gritty details involving carbon, etc., which can instead be included as part of our observations Y .
- We wish to minimize the risk of anthropocentric and “classical” bias when trying to establish the correspondence between locations and perceptions. The term SAS emphasizes that this is to be approached as a mathematics problem, since the observer is nothing but part of the mathematical structure.
- We wish to keep the discussion general enough to be applicable even to other possible life-forms.
- The possibility of making *a priori* “Descartes” predictions, based on nothing but the fact that we exist and think, offers a way of potentially ruling out the 1a TOE that would otherwise be overlooked.

IV. OUR “LOCAL ISLAND”

In section II, we took a top-down look at mathematical structures, starting with the most general ones and specializing to more specific ones. In this section, we will do the opposite: beginning with what we know about our own mathematical structure, we will discuss what happens when changing it in various ways. In other words, we will discuss the borders of our own “habitable island” in the space of all mathematical structures, without being concerned about whether there are other habitable islands elsewhere. We will start by discussing the effects of relatively minor changes such as dimensionless continuous physical parameters and gradually proceed to more radical changes such as the dimensionality of space and time and the partial differential equations. Most of the material that we summarize in this section has been well-known for a long time, so rather than giving a large number of separate references, we simply refer the interested

reader to the excellent review given in [17]. Other extensive reviews can be found in [16,31,32], and the Resource Letter [18] contains virtually all references prior to 1991.

We emphasize that the purpose of this section is not to attempt to rigorously demonstrate that certain mathematical structures are devoid of SASs, merely to provide an overview of anthropic constraints and some crude plausibility arguments.

A. Different continuous parameters

Which dimensionless physical parameters are likely to be important for determining the ability of our Universe to contain SASs? The following six are clearly important for low-energy physics:

- α_s , the strong coupling constant
- α_w , the weak coupling constant
- α , the electromagnetic coupling constant
- α_g , the gravitational coupling constant
- m_e/m_p , the electron/proton mass ratio
- m_n/m_p , the neutron/proton mass ratio

We will use Planck units, so $\hbar = c = G = 1$ are not parameters, and masses are dimensionless, making the observed parameter vector

$$(\alpha_s, \alpha_w, \alpha, \alpha_g, m_e/m_p, m_n/m_p) \approx (0.12, 0.03, 1/137, 5.9 \times 10^{-39}, 1/1836, 1.0014). \quad (8)$$

Note that m_p is not an additional parameter, since $m_p = \alpha_g^{1/2}$. In addition, the cosmological constant [13] and the various neutrino masses will be important if they are non-zero, since they can contribute to the overall density of the universe and therefore affect both its expansion rate and its ability to form cosmological large-scale structure such as galaxies. How sensitive our existence is to the values of various high-energy physics parameters (e.g., the top quark mass) is less clear, but we can certainly not at this stage rule out the possibility that their values are constrained by various early-universe phenomena. For instance, the symmetry breaking that lead to a slight excess of matter over anti-matter was certainly crucial for the current existence of stable objects.

As was pointed out by Max Born, given that $m_n \approx m_p$, the gross properties of all atomic and molecular systems are controlled by only two parameters: α and $\beta \equiv m_e/m_p$. Some rather robust constraints on these parameters are illustrated by the four shaded regions in Figure 4. Here we have compactified the parameter space by plotting $\arctan[\lg(\beta)]$ against $\arctan[\lg(\alpha)]$, where the logarithms are in base 10, thus mapping the entire range $[0, \infty]$ into the range $[-\pi/2, \pi/2]$. First of all, the fact that $\alpha, \beta \ll 1$ is crucial for chemistry as we know it.

In a stable ordered structure (e.g., a chromosome), the typical fluctuation in the location of a nucleus relative to the inter-atomic spacing is $\beta^{1/4}$, so for such a structure to remain stable over long time scales, one must have $\beta^{1/4} \ll 1$. The figure shows the rather modest constraint $\beta^{1/4} < 1/3$. (This stability constraint also allows replacing β by $1/\beta$, which interchanges the roles of electrons and nucleons.) In contrast, if one tried to build up ordered materials using the strong nuclear force one would not have this important stability, since neutrons and protons have similar masses (this is why neither is localized with precision in nuclei, which all appear fairly spherically symmetric from the outside) [17].

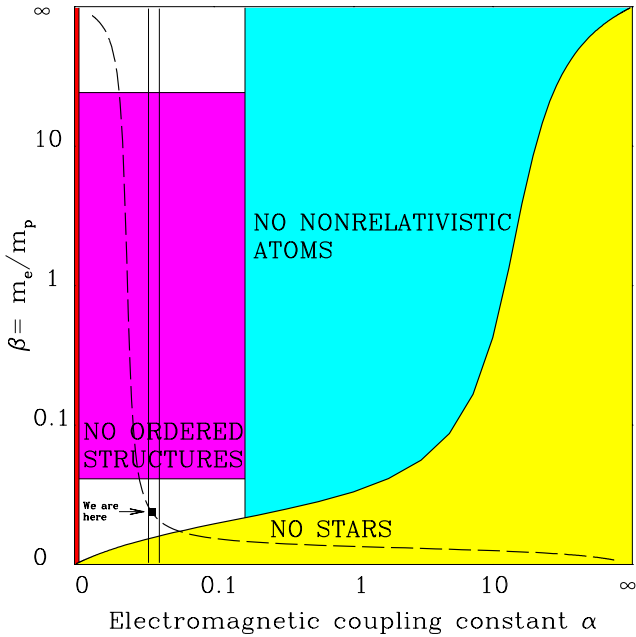

FIG. 4. Constraints on α and β

Various edges of our “local island” are illustrated in the parameter space of the fine structure constant α and the electron/proton mass ratio β . The observed values $(\alpha, \beta) \approx (1/137, 1/1836)$ are indicated with a filled square. Grand unified theories rule out everything except the narrow strip between the two vertical lines, and Carter’s stellar argument predicts a point on the dashed line. In the narrow shaded region to the very left, electromagnetism is weaker than gravity and therefore irrelevant.

The typical electron velocity in a hydrogen atom is α , so $\alpha \ll 1$ makes small atoms nonrelativistic and atoms and molecules stable against pair creation.

The third constraint plotted is obtained if we require the existence of stars. Insisting that the lower limit on the stellar mass (which arises from requiring the central temperature to be high enough to ignite nuclear fusion) not exceed the upper limit (which comes from requiring that the star be stable) [17], the dependence on α_g cancels

out and one obtains the constraint $\beta \gtrsim \alpha^2/200$.

A rock-bottom lower limit is clearly $\alpha \gtrsim \alpha_g$, since otherwise electrical repulsion would always be weaker than gravitational attraction, and the effects of electromagnetism would for all practical purposes be negligible. (More generally, if we let any parameter approach zero or infinity, the mathematical structure clearly loses complexity.)

If one is willing to make more questionable assumptions, far tighter constraints can be placed. For instance, requiring a grand-unified theory to unify all forces at an energy no higher than the Planck energy and requiring protons to be stable on stellar timescales gives $1/180 \lesssim \alpha \lesssim 1/85$, the two vertical lines in the figure. If it is true that a star must undergo a convective phase before arriving at the main sequence in order to develop a planetary system, then one obtains [15] the severe requirement $\alpha^{12}/\beta^4 \sim \alpha_g$, which is plotted (dashed curve) using the observed value of α_g .

In addition to the above-mentioned constraints, a detailed study of biochemistry reveals that many seemingly vital processes hinge on a large number of “coincidences” [17], ranging from the fact that water attains its maximum density above its freezing point to various chemical properties that enable high-fidelity DNA reproduction. Since all of chemistry is essentially determined by only two free parameters, α and β , it might thus appear as though there is a solution to an overdetermined problem with much more equations (inequalities) than unknowns. This could be taken as support for a religion-based category 2 TOE, with the argument that it would be unlikely in all other TOEs. An alternative interpretation is that these constraints are rather weak and not necessary conditions for the existence of SASs. In this picture, there would be a large number of tiny islands of habitability in the white region in Figure 4, and the SASs in other parts of this “archipelago” would simply evolve by combining chemical elements in a manner different from ours.

A similar constraint plot involving the strength of the strong interaction is shown in Figure 5. Whether an atomic nucleus is stable or not depends on whether the attractive force between its nucleons is able to overcome degeneracy pressure and Coulomb repulsion. The fact that the heaviest stable nuclei contain $Z \sim 10^2$ protons is therefore determined by α_s and α . If $\alpha_s \lesssim 0.3\alpha^{1/2}$ (a shaded region), not even carbon ($Z = 5$) would be stable [17], and it is doubtful whether the universe would still be complex enough to support SASs. Alternatively, increasing α_s by a mere 3.7% is sufficient to endow the diproton with a bound state [33]. This would have catastrophic consequences for stellar stability, as it would accelerate hydrogen burning by a factor of 10^{18} . In fact, this would lead to a universe devoid of Hydrogen (and thus free of water and organic chemistry), since all H would be converted to diprotons already during big bang nucleosynthesis. Reducing α_s by 11% (horizontal line) would unbind deuterium, without which the main nuclear reaction chain in the sun could not proceed. Although it

is unclear how necessary this is for SASs, “it is doubtful if stable, long-lived stars could exist at all” [16].

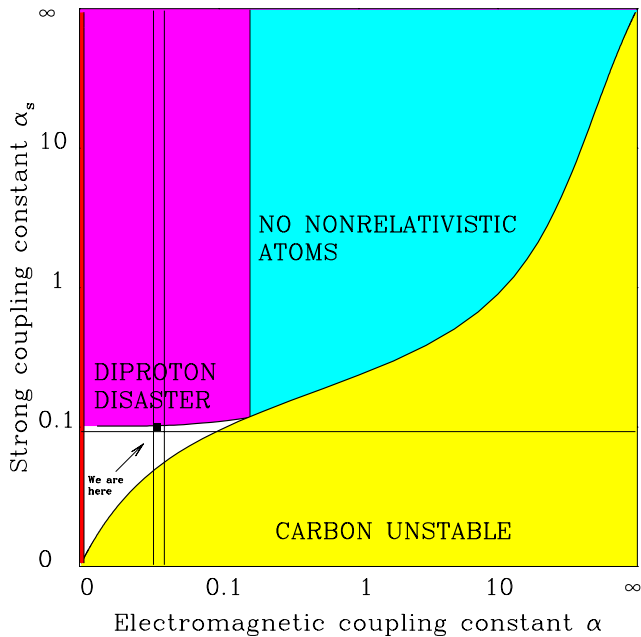

FIG. 5. Constraints on α and α_s

Various edges of our “local island” are illustrated in the parameter space of the electromagnetic and strong coupling constants, α and α_s . The observed values $(\alpha, \alpha_s) \approx (1/137, 0.1)$ are indicated with a filled square. Grand unified theories rule out everything except the narrow strip between the two vertical lines, and deuterium becomes unstable below the horizontal line. In the narrow shaded region to the very left, electromagnetism is weaker than gravity and therefore irrelevant.

Just as in Figure 4, we might expect a careful analysis of the white region to reveal a large number of tiny habitable islands. This time, the source of the many delicate constraints is the hierarchical process in which heavy elements are produced in stars, where it is sufficient to break a single link in the reaction chain to ruin everything. For instance, Hoyle realized that production of elements heavier than $Z = 4$ (Beryllium) required a resonance in the C^{12} nucleus at a very particular energy, and so predicted the existence of this resonance before it had been experimentally measured [34]. In analogy with the “archipelago” argument above, a natural conjecture is that if α_s and α are varied by large enough amounts, alternative reaction chains can produce enough heavy elements to yield a complex universe with SASs.

Since it would be well beyond the scope of this paper to enter into a detailed discussion of the constraints on all continuous parameters, we merely list some of the most robust constraints below and refer to [17,16] for details.

- α_s : See Figure 5.

- α_w : If substantially smaller, all hydrogen gets converted to helium shortly after the Big Bang. If much larger or much smaller, the neutrinos from a supernova explosion fail to blow away the outer parts of the star, and it is doubtful whether any heavy elements would ever be able to leave the stars where they were produced.
- α : See Figure 4 and Figure 5.
- α_g : The masses of planets, organisms on their surface, and atoms have the ratios $(\alpha/\alpha_g)^{3/2} : (\alpha/\alpha_g)^{3/4} : 1$, so unless $\alpha_g \ll \alpha$, the hierarchies of scale that characterize our universe would be absent. These distinctions between micro- and macro- may be necessary to provide stability against statistical $1/\sqrt{N}$ -fluctuations, as pointed out by Schrödinger after asking “Why are atoms so small?” [35]. Also note the Carter constraint in Figure 4, which depends on α_g .
- m_e/m_p : See Figure 4.
- m_n/m_p : If $m_n/m_p < 1 + \beta$, then neutrons cannot decay into protons and electrons, so nucleosynthesis converts virtually all hydrogen into helium. If $m_n/m_p < 1 - \beta$, then protons would be able to decay into neutrons and positrons, so there would be no stable atoms at all.

B. Different discrete parameters

1. Different number of spatial dimensions

In a world with the same laws of physics as ours but where the dimensionality of space n was different from three, it is quite plausible that no SASs would be possible.⁷ What is so special about $n = 3$? Perhaps the most striking property was pointed out by Ehrenfest in 1917 [37,38]: for $n > 3$, neither classical atoms nor planetary orbits can be stable. Indeed, as described below, quantum atoms cannot be stable either. These properties are related to the fact that the fundamental Green function of the Poisson equation $\nabla^2\phi = \rho$, which gives the electrostatic/gravitational potential of a point particle, is r^{2-n} for $n > 2$. Thus the inverse square law of electrostatics and gravity becomes an inverse cube law if $n = 4$, etc. When $n > 3$, the two-body problem no longer has any stable orbits as solutions [39,40]. This is illustrated in Figure 6, where a swarm of light test particles are incident from the left on a massive point particle (the

⁷This discussion of the dimensionality of spacetime is an expanded version of [36].

black dot), all with the same momentum vector but with a range of impact parameters.

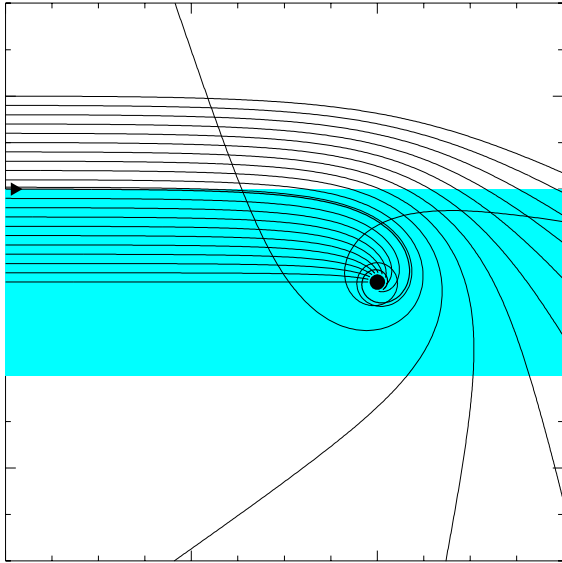

FIG. 6. The two body problem in four-dimensional space: the light particles that approach the heavy one at the center either escape to infinity or get sucked into a cataclysmic collision. There are no stable orbits.

There are two cases: those that start outside the shaded region escape to infinity, whereas those with smaller impact parameters spiral into a singular collision in a finite time. We can think of this as there being a finite cross section for annihilation. This is of course in stark contrast to the familiar case $n = 3$, which gives either stable elliptic orbits or non-bound parabolic and hyperbolic orbits, and has no “annihilation solutions” except for the measure zero case where the impact parameter is exactly zero. A similar disaster occurs in quantum mechanics, where a study of the Schrödinger equation shows that the Hydrogen atom has no bound states for $n > 3$ [41]. Again, there is a finite annihilation cross section, which is reflected by the fact that the Hydrogen atom has no ground state, but time-dependent states of arbitrarily negative energy. The situation in general relativity is analogous [41]. Modulo the important caveats mentioned below, this means that such a world cannot contain any objects that are stable over time, and thus almost certainly cannot contain SASs.

There is also a less dramatic way in which $n = 3$ appears advantageous (although perhaps not necessary) for SASs. Many authors (e.g., [37,38,42,43]) have drawn attention to the fact that the wave equation admits sharp and distortion-free signal propagation only when $n = 3$ (a property that we take advantage of when we see and listen). In addition, the Weyl equation exhibits a special “form stability” [44] for $n = 3$, $m = 1$.

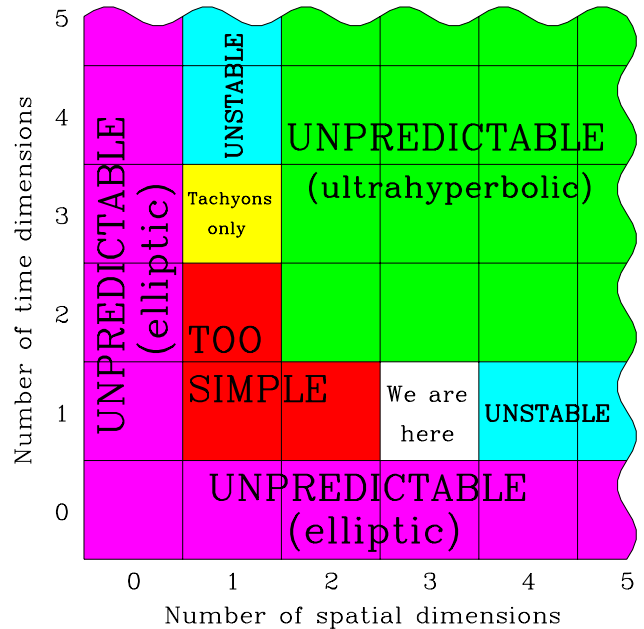

FIG. 7. Constraints on the dimensionality of spacetime.

When the partial differential equations are elliptic or ultrahyperbolic, physics has no predictive power for a SAS. In the remaining (hyperbolic) cases, $n > 3$ fails on the stability requirement (atoms are unstable) and $n < 3$ fails on the complexity requirement (no gravitational attraction, topological problems). A 1+3-dimensional spacetime is equivalent to a 3+1-dimensional one with tachyons only, and may fail on the stability requirement.

What about $n < 3$? It has been argued [45] that organisms would face insurmountable topological problems if $n = 2$: for instance, two nerves cannot cross. Another problem, emphasized by Wheeler [46], is the well-known fact (see e.g. [47]) that there is no gravitational force in general relativity with $n < 3$. This may appear surprising, since the Poisson equation of Newtonian gravity allows gravitational forces for $n < 3$. The fact of the matter is that general relativity has no Newtonian limit for $n < 3$, which means that a naive Newtonian calculation would simply be inconsistent with observations. In order for general relativity to possess a Newtonian limit, there must be a coordinate system where the metric tensor $g_{\mu\nu}$ approaches the Minkowski form far from any masses, and the Newtonian gravitational potential ϕ is then (apart from a factor of two) identified with the deviation of g_{00} from unity. However, a naive application of Newtonian gravity shows that the inverse r^2 law of $n = 3$ gets replaced by an inverse r law for $n = 2$, so instead of approaching zero as $r \rightarrow \infty$, ϕ diverges logarithmically. A general relativistic solution for a static point particle in 2 dimensional space (which is mathematically equivalent to the frequently studied problem of mass concentrated on an infinite line, interpreted as a cosmic string) shows that the surrounding space has no curvature (the Rie-

mann tensor vanishes), which means that other particles would not feel any gravitational attraction. Instead, the surrounding spacetime has the geometry of a cone, so that the total angle around the point mass is less than 360° , again illustrating the global nature of gravity in two dimensions and why there cannot be a Newtonian limit. In summary, there will not be any gravitational attraction if space has less than 3 dimensions, which precludes planetary orbits as well as stars and planets held together by gravity and SASs being gravitationally bound to rotating planets. We will not spend more time listing problems with $n < 3$, but simply conjecture that since $n = 2$ (let alone $n = 1$ and $n = 0$) offers vastly less complexity than $n = 3$, worlds with $n < 3$ are just too simple and barren to contain SASs.

For additional discussion of anthropic constraints on n , see e.g. [17,48].

2. Different number of time dimensions

Why is time one-dimensional? In this section, we will present an argument for why a world with the same laws of physics as ours and with an $n + m$ -dimensional spacetime can only contain SASs if the number of time-dimensions $m = 1$, regardless of the number of space-dimensions n . Before describing this argument, which involves hyperbolicity properties of partial differential equations, let us make a few general comments about the dimensionality of time.

Whereas the case $n \neq 3$ has been frequently discussed in the literature, the case $m \neq 1$ has received rather scant attention. This may be partly because the above-mentioned correspondence between the outside and inside viewpoints is more difficult to establish in the latter case. When trying to imagine life in 4-dimensional space, we can make an analogy with the step from a 2-dimensional world to our 3-dimensional one, much as was done in Edwin Abbot’s famous novel “Flatland”. But what would reality appear like to a SAS in a manifold with two time-like dimensions?

A first point to note is that even for $m > 1$, there is no obvious reason for why a SAS could not nonetheless *perceive* time as being one-dimensional, thereby maintaining the pattern of having “thoughts” and “perceptions” in the one-dimensional succession that characterizes our own reality perception. If a SAS is a localized object, it will travel along an essentially 1-dimensional (time-like) world line through the $n+m$ -dimensional spacetime manifold. The standard general relativity notion of its proper time is perfectly well-defined, and we would expect this to be the time that it would measure if it had a clock and that it would subjectively experience.

a. Differences when time is multidimensional Needless to say, many aspects of the world would nonetheless appear quite different. For instance, a re-derivation of relativistic mechanics for this more general case shows

that energy now becomes an m -dimensional vector rather than a constant, whose direction determines in which of the many time-directions the world-line will continue, and in the non-relativistic limit, this direction is a constant of motion. In other words, if two non-relativistic observers that are moving in different time directions happen to meet at a point in spacetime, they will inevitably drift apart in separate time-directions again, unable to stay together.

Another interesting difference, which can be shown by an elegant geometrical argument [49], is that particles become less stable when $m > 1$. For a particle to be able to decay when $m = 1$, it is not sufficient that there exists a set of particles with the same quantum numbers. It is also necessary, as is well-known, that the sum of their rest masses should be less than the rest mass of the original particle, regardless of how great its kinetic energy may be. When $m > 1$, this constraint vanishes [49]. For instance,

- a proton can decay into a neutron, a positron and a neutrino,
- an electron can decay into a neutron, an antiproton and a neutrino, and
- a photon of sufficiently high energy can decay into any particle and its antiparticle.

In addition to these two differences, one can concoct seemingly strange occurrences involving “backward causation” when $m > 1$. Nonetheless, although such unfamiliar behavior may appear disturbing, it would seem unwarranted to assume that it would prevent any form of SAS from existing. After all, we must avoid the fallacy of assuming that the design of our human bodies is the only one that allows self-awareness. Electrons, protons and photons would still be stable if their kinetic energies were low enough, so perhaps observers could still exist in rather cold regions of a world with $m > 1$.⁸ There is, however, an additional problem for SASs when $m > 1$, which has not been previously emphasized even though the mathematical results on which it is based are well-known. It stems from the requirement of *predictability* which was discussed in Section III.⁹ If a SAS is to be able to make

⁸ It is, however, far from trivial to formulate a quantum field theory with a stable vacuum state when $m > 1$. A detailed discussion of such instability problems with $m > 1$ is given by Linde [3], also in an anthropic context, and these issues are closely related to the ultrahyperbolic property described below.

⁹ The etymology of *predict* makes it a slightly unfortunate word to use in this context, since it might be interpreted as presupposing a one-dimensional time. We will use it to mean merely making inferences about other parts of the space-time manifold based on local data.

any use of its self-awareness and information-processing abilities (let alone function), the laws of physics must be such that it can make at least some predictions. Specifically, within the framework of a field theory, it should be able to measure various nearby field values and compute field values at some more distant space-time points (ones lying along its future world-line being particularly useful) with non-infinite error bars. Although this predictability requirement may sound modest, it is in fact only met by a small class of partial differential equations (PDEs), essentially those which are hyperbolic.

b. The PDE classification scheme All the mathematical material summarized below is well-known, and can be found in more detail in [43]. Given an arbitrary second order linear partial differential equation in \mathbf{R}^d ,

$$\left[\sum_{i=1}^d \sum_{j=1}^d A_{ij} \frac{\partial}{\partial x_i} \frac{\partial}{\partial x_j} + \sum_{i=1}^d b_i \frac{\partial}{\partial x_i} + c \right] u = 0, \quad (9)$$

where the matrix A (which we without loss of generality can take to be symmetric), the vector b and the scalar c are given differentiable functions of the d coordinates, it is customary to classify it depending on the signs of the eigenvalues of A . The PDE is said to be

- *elliptic* in some region of \mathbf{R}^d if they are all positive or all negative there,
- *hyperbolic* if one is positive and the rest are negative (or vice versa), and
- *ultrahyperbolic* in the remaining case, i.e., where at least two eigenvalues are positive and at least two are negative.

What does this have to do with the dimensionality of spacetime? For the various covariant field equations of nature that describe our world (the wave equation $u_{,\mu\mu} = 0$, the Klein-Gordon equation $u_{,\mu\mu} + m^2 u = 0$, etc.¹⁰), the matrix A will clearly have the same eigenvalues as the metric tensor. For instance, they will be hyperbolic in a metric of signature $(+ - -)$, corresponding to $(n, m) = (3, 1)$, elliptic in a metric of signature $(+ + + +)$, corresponding to $(n, m) = (5, 0)$, and ultrahyperbolic in a metric of signature $(+ + - -)$.

c. Well-posed and ill-posed problems One of the merits of this standard classification of PDEs is that it determines their causal structure, i.e., how the boundary conditions must be specified to make the problem *well-posed*.

Roughly speaking, the problem is said to be well-posed if the boundary conditions determine a unique solution u and if the dependence of this solution on the boundary data (which will always be linear) is *bounded*. The last requirement means that the solution u at a given point will only change by a finite amount if the boundary data is changed by a finite amount. Therefore, even if an ill-posed problem can be formally solved, this solution would in practice be useless to a SAS, since it would need to measure the initial data with infinite accuracy to be able to place finite error bars on the solution (any measurement error would cause the error bars on the solution to be infinite).

d. The elliptic case Elliptic equations allow well-posed *boundary value problems*. For instance, the d -dimensional Laplace equation $\nabla^2 u = 0$ with u specified on some closed $(d - 1)$ -dimensional hypersurface determines the solution everywhere inside this surface. On the other hand, giving “initial” data for an elliptic PDE on a non-closed surface, say a plane, is an ill-posed problem.¹¹ This means that a SAS in a world with no time dimensions ($m=0$) would not be able to make any inferences at all about the situation in other parts of space based on what it observes locally. Such worlds thus fail on the above-mentioned predictability requirement, as illustrated in Figure 7.

e. The hyperbolic case Hyperbolic equations, on the other hand, allow well-posed *initial-value problems*. For the Klein-Gordon equation in $n+1$ dimensions, specifying initial data (u and \dot{u}) on a region of a spacelike hypersurface determines u at all points for which this region slices all through the backward light-cone, as long as $m^2 \geq 0$ — we will return to the Tachyonic case $m^2 < 0$ below. For example, initial data on the shaded disc in Figure 8 determines the solution in the volumes bounded by the two cones, including the (missing) tips. A localized SAS can therefore make predictions about its future. If the matter under consideration is of such low temperature that it is nonrelativistic, then the fields will essentially contain only Fourier modes with wave numbers $|\mathbf{k}| \ll m$, which means that for all practical purposes, the solution at a point is determined by the initial data in a “causality cone” with an opening angle much narrower than 45° . For instance, when we find ourselves in a bowling alley where no relevant macroscopic velocities exceed 10 m/s, we can use information from a spatial hypersurface of 10 meter radius (a spherical volume) to make predictions an entire second into the future.

¹⁰ Our discussion will apply to matter fields with spin as well, e.g. fermions and photons, since spin does not alter the causal structure of the solutions. For instance, all four components of an electron-positron field obeying the Dirac equation satisfy the Klein-Gordon equation as well, and all four components of the electromagnetic vector potential in Lorentz gauge satisfy the wave equation.

¹¹ Specifying only u on a non-closed surface gives an underdetermined problem, and specifying additional data, e.g., the normal derivative of u , generally makes the problem overdetermined and ill-posed in the same way as the ultrahyperbolic case described below.

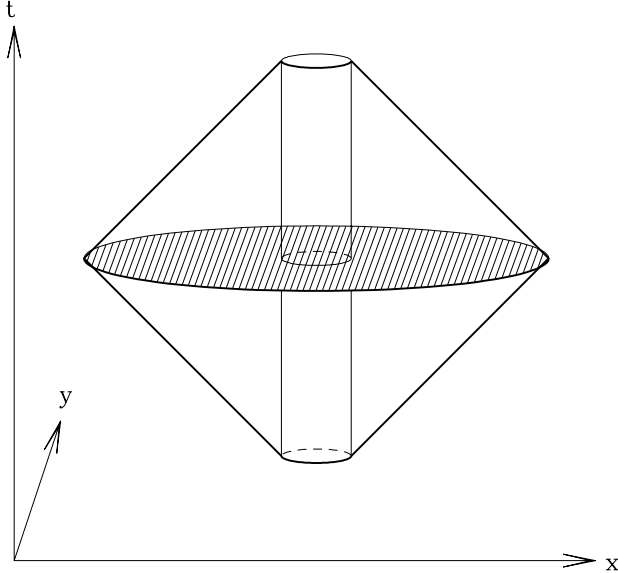

FIG. 8. The causality structure for hyperbolic and ultra-hyperbolic equations.

f. The hyperbolic case with a bad hypersurface In contrast, if the initial data for a hyperbolic PDE is specified on a hypersurface that is not spacelike, the problem becomes ill-posed. Figure 8, which is based on [43], provides an intuitive understanding of what goes wrong. A corollary of a remarkable theorem by Asgeirsson [50] is that if we specify u in the cylinder in Figure 8, then this determines u throughout the region made up of the truncated double cones. Letting the radius of this cylinder approach zero, we obtain the disturbing conclusion that providing data in a for all practical purposes one-dimensional region determines the solution in a three-dimensional region. Such an apparent “free lunch”, where the solution seems to contain more information than the input data, is a classical symptom of ill-posedness. The price that must be paid is specifying the input data with infinite accuracy, which is of course impossible given real-world measurement errors.¹² Moreover, no matter how nar-

¹² A similar example occurs if all we know about a mapping f in the complex plane is that it is an analytic function. Writing $z = x + iy$ and $f(x + iy) = u(x, y) + iv(x, y)$, where x, y, u and v are real, the analyticity requirement corresponds to the Cauchy-Riemann PDEs

$$\frac{\partial u}{\partial x} = \frac{\partial v}{\partial y}, \quad \frac{\partial u}{\partial y} = -\frac{\partial v}{\partial x}. \quad (10)$$

It is well-known that knowledge of f in an infinitesimal neighborhood of some point (for all practical purposes a zero-dimensional region) uniquely determines f everywhere in the complex plane. However, this important mathematical prop-

erty would be practically useless for a SAS at the point trying to predict its surroundings, since the reconstruction is ill-posed: it must measure f to infinitely many decimal places to be able to make any predictions at all, since its Taylor series requires knowledge of an infinite number of derivatives.

row we make the cylinder, the problem is always overdetermined, since data in the outer half of the cylinder are determined by that in the inner half. Thus measuring data in a larger region does not eliminate the ill-posed nature of the problem, since the additional data carries no new information. Also, generic boundary data allows no solution at all, since it is not self-consistent. It is easy to see that the same applies when specifying “initial” data on part of a non-spacelike hypersurface, e.g., that given by $y = 0$. These properties are analogous in $n + 1$ -dimensions, and illustrate why a SAS in an $n + 1$ -dimensional spacetime can only make predictions in time-like directions.

g. The ultrahyperbolic case Asgeirsson’s theorem applies to the ultrahyperbolic case as well, showing that initial data on a hypersurface containing both spacelike and timelike directions leads to an ill-posed problem. However, since a hypersurface by definition has a dimensionality which is one less than that of the spacetime manifold (data on a submanifold of lower dimensionality can never give a well-posed problem), *there are no spacelike or timelike hypersurfaces* in the ultrahyperbolic case, i.e., when the number of space- and time-dimensions both exceed one. In other words, worlds in the region labeled ultrahyperbolic in Figure 7 cannot contain SASs if we insist on the above-mentioned predictability requirement.¹³ Together with the above-mentioned complexity and stability requirements, this rules out all combinations (n, m) in Figure 7 except $(3, 1)$. We see that what makes the number 1 so special is that a hypersurface in a manifold has a dimensionality which is precisely 1 less than that of the manifold itself (with more than one time-dimension, a hypersurface cannot be purely spacelike).

h. Space-time dimensionality: summary Here we have discussed only linear PDEs, although the full system of coupled PDEs of nature is of course non-linear. This in no way weakens our conclusions about only $m = 1$ giving well-posed initial value problems. When PDEs give ill-posed problems even *locally*, in a small neighborhood of a hypersurface (where we can generically approximate the nonlinear PDEs with linear ones), it is obvious that no nonlinear terms can make them well-posed in a larger neighborhood. Contrariwise, adding nonlinear terms occasionally makes well-posed problems ill-posed.

¹³The only remaining possibility is the rather contrived case where data are specified on a null hypersurface. To measure such data, a SAS would need to “live on the light cone”, i.e., travel with the speed of light, which means that it would subjectively not perceive any time at all (its proper time would stand still).

We summarize this section as follows, graphically illustrated in Figure 7. In our 1a TOE, there are mathematical structures with PE that have exactly our laws of physics but with different space-time dimensionality. It appears likely that all except the 3+1-dimensional one are devoid of SASs, for the following reasons:

- More or less than 1 time dimension: insufficient predictability.
- More than 3 space dimensions: insufficient stability.
- Less than 3 space dimensions: insufficient complexity.

Once again, these arguments are of course not to be interpreted as a rigorous proof. For instance, within the context of specific models, one might consider exploring the possibility of stable structures in the case $(n, m) = (4, 1)$ based on short distance quantum corrections to the $1/r^2$ potential or on string-like (rather than point-like) particles [51]. We have simply argued that it is far from obvious that any other combination than $(n, m) = (3, 1)$ permits SASs, since radical qualitative changes occur when n or m is altered.

3. Including tachyonic particles

If spacetime were 1+3-dimensional instead of 3+1-dimensional, space and time would effectively have interchanged their roles, except that m^2 in a Klein-Gordon equation would have its sign reversed. In other words, a 1+3-dimensional world would be just like ours except that all particles would be tachyons, as illustrated in Figure 7.

Many of the original objections towards tachyons have been shown to be unfounded [52], but it also appears premature to conclude that a world with tachyons could provide SASs with the necessary stability and predictability. Initial value-problems are still well-posed when data is given on a spacelike hypersurface, but new instabilities appear. A photon of arbitrary energy could decay into a tachyon-antitachyon pair [49], and the other forbidden decays that we discussed above (in the context of multidimensional time) would also become allowed. In addition, fluctuations in the Tachyon field of wavelength above $1/m$ would be unstable and grow exponentially rather than oscillate. This growth occurs on a timescale $1/m$, so if our Universe had contained a Tachyon field with $m \gtrsim 1/10^{17}$ seconds, it would have dominated the cosmic density and caused the Universe to recollapse in a big crunch long ago. This is why the $(n, m) = (1, 3)$ box is tentatively part of the excluded region in Figure 7.

C. Other obvious things to change

Many other obvious small departures from our island of habitability remain to be better explored in this framework, for instance:

- Changing the spacetime topology, either on cosmological scales or on microscopical scales.
- Adding and removing low-mass particles (fields).
- Adding tachyonic particles (fields), as touched upon above.
- Making more radical changes to the partial differential equations. The notion of hyperbolicity has been generalized also to PDEs of order higher than two, and also in these cases we would expect the predictability requirement to impose a strong constraint. Fully linear equations (where all fields are uncoupled) presumably lack the complexity necessary for SASs, whereas non-linearity is notorious for introducing instability and unpredictability (chaos). In other words, it is not implausible that there exists only a small number of possible systems of PDEs that balance between violating the complexity constraint on one hand and violating the predictability and stability constraints on the other hand.
- Discretizing or q -deforming spacetime.

V. CONCLUSIONS

We have proposed a “theory of everything” (TOE) which is in a sense the ultimate ensemble theory. In the Everett interpretation of nonrelativistic quantum mechanics, many macroscopically different states of the universe are all assumed to have physical existence (PE), but the structure of spacetime, the physical constants and the physical laws are assumed to be fixed. Some quantum gravity conjectures [53] endow not only different metrics but even different spacetime topologies with PE. It has also been suggested that physical constants may be different “after” a big crunch and a new big bang [54], thus endowing models with say different coupling constants and particle masses with PE, and this same ensemble has been postulated to have PE based on a wormhole physics argument [1]. It has been argued that models with different effective space-time dimensionality have PE, based on inflationary cosmology [2] or superstring theory [5]. The “random dynamics” program of Nielsen [55] has even endowed PE to worlds governed by a limited class of different equations, corresponding to different high-energy Lagrangeans. Our TOE takes this ensemble enlargement to its extreme, and postulates that all structures that exist in the mathematical sense (as described in Section II) exist in the physical sense as well. The elegance of this theory lies in its extreme simplicity, since it contains neither any free parameters nor any arbitrary assumptions about which of all mathematical equations are assumed to be “the real ones”.

The picture is that some of these mathematical structures contain “self-aware substructures” (SASs), and that we humans are an example of such SASs. To calculate the physical predictions of the theory, we therefore need to address the following questions:

1. Which structures contain SASs?
2. How do these SASs perceive the structures that they are part of?
3. Given what we perceive, which mathematical structures are most likely to be the one that we inhabit?
4. Given specific experimental observations (perceptions), what are the probability distributions for experimental outcomes when using Bayesian statistics to reflect our lack of knowledge (as to which structure we inhabit, as to measurement errors, etc.)?

Needless to say, these are all difficult questions, and an exhaustive answer to any one of them would of course be far beyond the scope of a single paper. For example, many person-years have already been spent on investigating whether string theory is a candidate under item 3. In this paper, we have merely attempted to give an introductory discussion of these four questions, and we summarize our findings under the four headings below.

A. Which structures contain SASs?

As robust necessary conditions for the existence of SASs, we proposed three criteria:

- Complexity
- Predictability
- Stability

The last two are clearly only meaningful for SAS that “think” and thus subjectively perceive some form of time. Using the terminology of Carter [15], we are asking how large the “cognizable” part of the grand ensemble is. In Section II, we set an upper limit on its size by exploring the ensemble of all mathematical structures, thereby placing Nozick’s notion [7] of “all logically acceptable worlds” on a more rigorous footing. We noted that if one keeps adding additional axioms to a formal system in an attempt to increase its complexity, one generically reaches a point where the balloon bursts: the formal system becomes inconsistent, all WFFs become theorems, and the mathematical structure becomes trivial and loses all its complexity.

In Section IV, we replaced this “top-down” approach with a “bottom-up” approach, making an overview of our local neighborhood in “mathematics space”. The constraints summarized here were all from previously published work except for a few new observations regarding the dimensionality of time and space.

In the six-dimensional space spanned by the low-energy-physics parameters α_s , α_w , α , α_g , m_e/m_p and m_n/m_p , we found that an “archipelago” picture emerged when assuming that the existence of SASs requires a certain minimum complexity, predictability and stability. As has been frequently emphasized, the local “island of habitability” to which our world belongs is quite small, extending only over relative parameter variations of order 10^{-2} . However, since the number of constraints for our own particular existence is much greater than the number of free parameters, we argued that it is likely that there is an archipelago of many such small islands, corresponding to different nuclear reaction chains in stellar burning and different chemical compositions of the SASs. The presence of a smaller number of much more severe constraints indicates that this archipelago also has an end, so that large regions on parameter space are likely to be completely devoid of SASs, and it is likely that the total number of islands is finite.

In the discrete two-dimensional space corresponding to different numbers of space and time dimensions, all but the combination 3+1 appear to be “dead worlds”, devoid of SASs. If there were more or less than one time-dimension, the partial differential equations of nature would lack the hyperbolicity property that enables SASs to make predictions. If space has a dimensionality exceeding three, there are no atoms or other stable structures. If space has a dimensionality of less than three, it

is doubtful whether the world offers sufficient complexity to support SASs (for instance, there is no gravitational force).

We concluded that the requirements of complexity, predictability and stability are extremely restrictive in our “local neighborhood” of mathematical structures, so it is not implausible that that islands of habitability are small and rare elsewhere in “mathematics space” as well. For this reason, it is not obvious that there is more than a finite number of mathematical structures containing SASs that are perceptibly different (according to their SASs), so that it might even be possible to catalogue all of them.

Many other obvious small departures from our island of habitability remain to be better explored in this framework, for instance changing the spacetime topology on sub-horizon scales, adding and removing low-mass particles, adding tachyonic particles, making more radical changes to the partial differential equations and discretizing or q -deforming spacetime.

B. How do SASs perceive the structures that they are part of?

In Section III, we argued that the development of relativity theory and quantum mechanics has taught us that we must carefully distinguish between two different views of a mathematical structure:

- The *bird perspective* or *outside view*, which is the way a mathematician views it.
- The *frog perspective* or *inside view*, which is the way it is perceived by a SAS in it.

Understanding how to predict the latter from the former is one of the major challenges in working out the quantitative predictions of our proposed TOE — and indeed in working out the quantitative predictions of *any* physical theory which is based on mathematics. Perhaps the best guide in addressing this question is what we have (arguably) learned from previous successful theories:

- The correspondence between the two viewpoints has become more subtle in each new theory (special relativity, general relativity, quantum mechanics), so we should expect it to be extremely subtle in a quantum gravity theory and try to break all our shackles of preconception as to what sort of mathematical structure we are looking for. Otherwise we might not even recognize the correct equations if we see them.
- We can only perceive those aspects of the mathematical structure that are independent of our notation for describing it. For instance, if the mathematical structure involves a manifold, a SAS can only perceive properties that have general covariance.

- We seem to perceive only those aspects of the structure (and of ourselves) which are useful to perceive, i.e., which are relatively stable and predictable (this is presumably because our design is related to Darwinian evolution).

- Example 1: We perceive ourselves as “local” even if we are not. Although in the bird perspective of general relativity we are one-dimensional world lines in a static four-dimensional manifold, we perceive ourselves as points in a three-dimensional world where things happen.
- Example 2: We perceive ourselves as stable and permanent even if we are not. (We replace the bulk of both our hardware (cells) and software (memories) many times in our lifetime).
- Example 3: We perceive ourselves as unique and isolated systems even if we are not. Although in the bird perspective of universally valid quantum mechanics we can end up in several macroscopically different configurations at once, intricately entangled with other systems, we perceive ourselves as remaining unique isolated systems merely experiencing a slight randomness.

- There can be ensembles within the ensemble: even within a single mathematical structure (such as quantum mechanics), different SASs can perceive different and for all practical purposes independent physical realities.

C. Which mathematical structure do we inhabit?

This question can clearly only be addressed by continued physics research along conventional lines, although we probably need to complement mathematical and experimental efforts with more work on understanding the correspondence between the inside and outside viewpoints.

Since some aspects of complex mathematical structures can often be approximated by simpler ones, we might never be able to determine precisely which one we are part of. However, if this should turn out to be the case, it clearly will not matter, since we can then obtain all possible physical predictions by just assuming that our structure is the simplest of the candidates.

D. Calculating probability distributions

All predictions of this theory take the form of probability distributions for the outcomes of future observations,

as formally given by equation (6). This equation basically states that the probability distribution for observing X a time Δt after observing Y is a sum giving equal weight to all mathematical structures that are consistent with both X and Y . As mentioned in the introduction, this is in fact quite similar to how predictions are made with 1b TOEs, the difference being simply that the sum is extended over *all* mathematical structures rather than just a single one or some small selection. It is convenient to discard all mathematical structures that do obviously not contain SASs once and for all, as this greatly cuts down the number of structures to sum over. This is why it is useful to identify and weed out “dead worlds” as was done in section IV. After this first cut, all additional observations about the nature of our world of course provide additional cuts in the number of structures to sum over.

E. Arguments against this theory

Here we discuss a few obvious objections to the proposed theory.

1. The falsifiability argument

Using Popper’s falsifiability requirement, one might argue that “*this TOE does not qualify as a scientific theory, since it cannot be experimentally ruled out*”. In fact, a moment of consideration reveals that this argument is false. The TOE we have proposed makes a large number of statistical predictions, and therefore *can* eventually be ruled out at high confidence levels if it is incorrect, using prediction 1 from the introduction as embodied in equation (6). Prediction 2 from the introduction offers additional ways of ruling it out that other theories lack. Such rejections based on a single observation are analogous to those involving statistical predictions of quantum mechanics: Suppose that we prepare a silver atom with its spin in the z -direction and then measure its spin in a direction making an angle of $\theta = 3^\circ$ with the z -axis. Since the theory predicts the outcome to be “spin up” with a probability $\cos^2 \theta/2$, a single observation of “spin down” would imply that quantum mechanics had been ruled out at a confidence level exceeding 99.9%.¹⁴ Instead, the falsifiability argument can be applied against

¹⁴ Indeed, the author once thought that this TOE was ruled out by the observation that space is three-dimensional, since if all higher dimensionalities were at least as habitable for SASs as our own, the a priori probability of our living in a space so near the bottom of the list would be virtually zero. The theory is saved merely because of Ehrenfest’s observation that $n > 3$ precludes atoms, which the author was unaware of at the time (and independently rediscovered, just as many

rival TOEs in category 1b, as discussed in Section V F 4 below.

2. The pragmatism argument

One might argue that “*this TOE is useless in practice, since it cannot make any interesting predictions*”. This argument is also incorrect. First of all, if only one mathematical structure should turn out to be consistent with all our observations, then we will with 100% certainty know that this is the one we inhabit, and the 1a TOE will give identical predictions to the 1b TOE that grants only this particular structure PE. Secondly, probabilistic calculations as to which structure we inhabit can also provide quantitative predictions. It was such Bayesian reasoning that enabled Hoyle to predict the famous 7.7 MeV resonance in the C^{12} nucleus [34], and we would expect the derived probability distributions to be quite narrow in other cases as well when parameters appear in exponentials. Although many in principle interesting calculations (such as the high-resolution version of Figure 5 suggested above) are numerically very difficult at the present stage, there are also areas where this type of calculations do not appear to be unfeasibly difficult. The parameters characterizing cosmological initial conditions provide one such example where work has already been done [13,4]. Shedding more light on the question of whether or not particle physicists should expect a “mass desert” up to near the Planck scale might also be possible by a systematic study of the extent to which “generic” models are consistent with our low-energy observations [55].

When it comes to discrete parameters, our TOE in fact makes some strikingly specific *a priori* predictions given the other laws of physics, such as that our spacetime should be 3+1-dimensional (see Figure 7). Thus an extremely prodigal new-born baby could in principle, before opening its eyes for the first time, paraphrase Descartes by saying “*cogito, ergo space is three-dimensional*”.

3. The economy argument

One might argue that this TOE is vulnerable to Occam’s razor, since it postulates the existence of other worlds that we can never observe. *Why should nature be so wasteful and indulge in such opulence as to contain an infinite plethora of different worlds?*

Intriguingly, this argument can be turned around to argue *for* our TOE. When we feel that nature is wasteful according to this theory, what precisely are we disturbed about her wasting? Certainly not “space”, since

others have).

we are perfectly willing to accept a single Friedmann-Robertson-Walker Universe with an infinite volume, most of which we can never observe — we accept that this unobservable space has PE since it allows a simpler theory. Certainly not “mass” or “atoms”, for the same reason — once you have wasted an infinite amount of something, who cares if you waste some more? Rather, it is probably the apparent reduction in simplicity that appears disturbing, the quantity of information necessary to specify all these unseen worlds. However, as is discussed in more detail in [56], *an entire ensemble is often much simpler than one of its members*, which can be stated more formally using the notion of *algorithmic information content* [57,58], also referred to as *algorithmic complexity*. For instance, the algorithmic information in a number is roughly speaking defined as the length (in bits) of the shortest computer program which will produce that number as output, so the information content in a generic integer n is of order $\log_2 n$. Nonetheless, the set of all integers $1, 2, 3, \dots$ can be generated by quite a trivial computer program [59], so the algorithmic complexity of the whole set is smaller than that of a generic member. Similarly, the set of all perfect fluid solutions to the Einstein field equations has a smaller algorithmic complexity than a generic particular solution, since the former is specified simply by giving a few equations and the latter requires the specification of vast amounts of initial data on some hypersurface. Loosely speaking, the apparent information content rises when we restrict our attention to one particular element in an ensemble, thus losing the symmetry and simplicity that was inherent in the totality of all elements taken together. In this sense, our “ultimate ensemble” of all mathematical structures has virtually no algorithmic complexity at all. Since it is merely in the frog perspective, in the subjective perceptions of SASs, that this opulence of information and complexity is really there, one can argue that an ensemble theory is in fact more economical than one endowing only a single ensemble element with PE [56].

F. Arguments against the rival theories

Here we discuss some objections to rival TOEs. The first two arguments are against those in Category 2, and the second two against those in Category 1b.

1. The success of mathematics in the physical sciences

In a his famous essay “The Unreasonable Effectiveness of Mathematics in the Natural Sciences” [60], Wigner argues that “the enormous usefulness of mathematics in the natural sciences is something bordering on the mysterious”, and that “there is no rational explanation for it”. This can be used as an argument against TOEs in category 2. For 1a and 1b TOEs, on the other hand,

the usefulness of mathematics for describing the physical world is a natural consequence of the fact that the latter *is* a mathematical structure. The various approximations that constitute our current physics theories are successful because simple mathematical structures can provide good approximations of how a SAS will perceive more complex mathematical structures. In other words, our successful theories are not mathematics approximating physics, but mathematics approximating mathematics!

In our category 1a TOE, Wigner’s question about why there are laws of physics that we are able to discover follows from the above-mentioned predictability requirement. In short, we can paraphrasing Descartes: “*Cogito, ergo lex.*”

2. The generality of mathematics

A second challenge for defenders of a Category 2 TOE is that mathematics is far more than the study of numbers that is taught in school. The currently popular formalist definition of mathematics as the study of formal systems [61] (which is reflected in our discussion of mathematical structures in Section II) is so broad that for all practical purposes, *any* TOE that is definable in purely formal terms (independent of vague human terminology) will fall into Category 1 rather than 2. For instance, a TOE involving a set of different types of entities (denoted by words, say) and relations between them (denoted by additional words) is nothing but what mathematicians call a set-theoretical model, and one can generally find a formal system that it is a model of. Since proponents of a Category 2 TOE must argue that some aspects of it are *not* mathematical, they must thus maintain that the world is in some sense not describable at all. Physicists would thus be wasting their time looking for such a TOE, and one can even argue about whether such a TOE deserves to be called a theory in the first place.

3. The smallness of our island

If the archipelago of habitability covers merely an extremely small fraction of our local neighborhood of “mathematics space”, then a Category 1b TOE would provide no explanation for the “miracle” that the parameter values of the existing world happen to lie in the range allowing SASs. For instance, if nuclear physics calculations were to show that stellar heavy element production requires $1/137.5 < \alpha < 1/136.5$ and a 1b TOE would produce a purely numerical calculation based on gravity quantization giving $\alpha = 1/137.0359895$, then this “coincidence” would probably leave many physicists feeling disturbed. Why should the existence of life arise from a remarkable feat of fine-tuning on the part of nature? However, in all fairness, we must bear in mind that extreme smallness of the archipelago (and indeed

even extreme smallness of our own island) has not been convincingly demonstrated, as stressed by e.g. [62]. Even the dimensionality observation mentioned in footnote 14 hardly qualifies as such a fine-tuning argument, since a small integer appearing from a calculation would appear far less arbitrary than an enormous integer or a number like 137.0359895. Rather, we mention this fine tuning issue simply to encourage actual calculations of how small the islands are.

4. *Physical nonexistence is a scientifically meaningless concept*

The claim that some mathematical structure (different from ours) does *not* have physical existence is an empirically completely useless statement, since it does not lead to any testable predictions, not even probabilistic ones. Nonetheless, it is precisely such claims that all TOEs in category 1b must make to distinguish themselves from the 1a TOE. This makes them vulnerable to Popper’s criticism of not qualifying as physical theories, since this aspect of them is not falsifiable. As an example, let us suppose that a detailed calculation shows that only five tiny islands in Figure 5 allow heavy element production in stars, with a total area less than 10^{-6} of the total in the plot. In a 1b TOE predicting the observed values, this would *not* allow us to say that the theory had been ruled out with 99.9999% significance, nor at any significance level at all, simply because, contrary to the 1a TOE, there is no ensemble from which probabilities emerge. However uncomfortable we might feel about the seeming “miracle” that the theory happened to predict parameter values allowing life, a defender of the theory could confidently ignore our unease, knowing that the claimed nonexistence of worlds with other parameter values could never be falsified.

Moreover, purely philosophical arguments about whether certain mathematical structures have PE or not (which is the sole difference between 1a and 1b TOEs) appear about as pointless as the medieval purely philosophical arguments about whether there is a God or not, when we consider that the entire notion of PE is painfully poorly defined. Would most physicists attribute PE to galaxies outside of our horizon volume? To unobservable branches of the wavefunction? If a mathematical structure contains a SAS, then the claim that it has PE operationally means that this SAS will perceive itself as existing in a physically real world, just as we do¹⁵. For the many other mathematical structures that correspond

¹⁵ We could eliminate the whole notion of PE from our TOE by simply rephrasing it as “*if a mathematical structure contains a SAS, it will perceive itself as existing in a physically real world*”.

to dead worlds with no SASs there to behold them, for instance the 4+1-dimensional (atom-free) analog of our world, who cares whether they have PE or not? In fact, as discussed in [56] and above in Section VE 3, the totality of all worlds is much less complex than such a specific world, and it is only in the subjective frog perspective of SASs that seemingly complex structures such as trees and stellar constellations exist at all. Thus in this sense, not even the pines and the Big Dipper of our world would exist if neither we nor any other SASs were here to perceive them. The answer to Hawking’s question “what is it that breathes fire into the equations and makes a Universe for them to describe?” [63] would then be “you, the SAS”.

Further attacking the distinction between physical and mathematical existence, one can speculate that future physicists will find the 1a TOE to be true *tautologically*¹⁶.

¹⁶ Penrose has raised the following question [64]. Suppose that a machine “android” were built that simulated a human being so accurately that her friends could not tell the difference. Would it be self-aware, i.e., subjectively feel like she does? If the answer to this question is yes (in accordance with Leibniz’ “identity of indiscernibles” [21]), then as described below, it might be untenable to make any distinction at all between physical existence and mathematical existence, so that our TOE would in fact be tautologically true.

Let us imagine a hypothetical Universe much larger than our own, which contains a computer so powerful that it can simulate the time-evolution of our entire Universe. By hypothesis, the humans in this simulated world would perceive their world as being as real as we perceive ours, so by definition, the simulated universe would have PE. Technical objections such as an infinite quantity of information being required to store the data appear to be irrelevant to the philosophical point that we will make. For instance, there is nothing about the physics we know today that suggests that the Universe could not be replaced by a discrete and finite model that approximated it so closely that we, its inhabitants, could not tell the difference. That a vast amount of CPU-time would be needed is irrelevant, since that time bears no relation to the subjective time that the inhabitants of the Universe would perceive. In fact, since we can choose to picture our Universe not as a 3D world where things happen, but as a 4D world that merely is, there is no need for the computer to compute anything at all — it could simply store all the 4D data, and the “simulated” world would still have PE. Clearly the way in which the data are stored should not matter, so the amount of PE we attribute to the stored Universe should be invariant under data compression. The physical laws provide a great means of data compression, since they make it sufficient to store the initial data at some time together with the equations and an integration routine. In fact, this should suffice even if the computer lacks the CPU power and memory required to perform the decompression. The initial data might be simple as well [56], containing so little algorithmic information that a single CD-ROM would suffice to store it. After all, all that

This would be a natural extension of a famous analogy by Eddington [28]:

- One might say that wherever there is light, there are associated ripples in the electromagnetic field. But the modern view is that light *is* the ripples.
- One might say that wherever there is matter, there are associated ripples in the metric known as curvature. But Eddington’s view is that matter *is* the ripples.
- One might say that wherever there is PE, there is an associated mathematical structure. But according to our TOE, physical existence *is* the mathematical structure.

G. And now what?

If the TOE we have proposed is correct, then what are the implications? As mentioned, answering the question of which mathematical structure we inhabit requires “business as usual” in terms of continuing theoretical and experimental research. However, there are also a number of implications for how we should focus our physics research, as summarized below.

1. Don’t mock e.g. string theorists

In coffee rooms throughout the world, derogatory remarks are often heard to the effect that certain physics theories (string theory, quantum groups, certain approaches to quantum gravity, occasionally also grand unified and supersymmetric theories), are mere mathematical diversions, having nothing to do with physical reality. According to our TOE, *all* such mathematical structures have physical existence if they are self-consistent, and therefore merit our study unless it can be convincingly

the needs to be stored is a description of the mathematical structure that is isomorphic to the simulated universe. Now the ultimate question forces itself upon us: for this Universe to have PE, is the CD-ROM really needed at all? If this magic CD-ROM could be contained within the simulated Universe itself, then it would “recursively” support its own PE. This would not involve any catch-22 “hen-and-egg” problem regarding whether the CD-ROM or the Universe existed first, since the Universe is a 4D structure which just is (“creation” is of course only a meaningful notion *within* a spacetime). In summary, a mathematical structure with SASs would have PE if it could be described purely formally (to a computer, say) — and this is of course little else than having mathematical existence. Some closely related arguments can be found in [21].

demonstrated that their properties preclude the existence of SASs ¹⁷.

2. Compute probability distributions for everything

One obvious first step toward more quantitative predictions from this TOE is to explore the parameter space of the various continuous and discrete physical parameters in more detail, to map out the archipelago of potential habitable islands. For instance, by using a crude model for how the relevant nuclear spectra depend on α and α_s , one should attempt to map out the various islands allowing an unbroken reaction chain for heavy element production in stars, thereby refining Figure 5. If the islands should turn out to cover only a tiny fraction of the parameter space, it would become increasingly difficult to believe in category 1b TOEs. As mentioned, this type of calculation also offers a way to test and perhaps rule out the TOE that we are proposing.

3. Study the formal structure

Since all mathematical structures are *a priori* given equal statistical weight, it is important to study the purely formal nature of the mathematical models that we propose. Would adding, changing or removing a few axioms produce an observationally equally viable model? For instance, if there is a large class of much more generic mathematical structures that would give identical predictions for low-energy physics but that would deviate at higher energies, then we would statistically expect to find such a deviation when our colliders become able to probe these energy scales. (Here we of course mean *mathematical* axioms, as in section II, not informal “axioms” regarding the correspondence between the mathematics and our observations, such as “Axiom 3 of the Copenhagen interpretation of quantum mechanics”.)

¹⁷ Although it is often said that “there are many perfectly good theories that simply turn out to be inconsistent with some experimental fact”, this statement is certainly exaggerated. The fact of the matter is that we to date have found *no* self-consistent mathematical structure that can demonstrably describe both quantum and general relativistic phenomena. Classical physics was certainly not “a perfectly good theory”, since it could not even account for electromagnetism with sources in a self-consistent way, and predicted that Hydrogen atoms would collapse in a fraction of a second. In 1920, Herman Weyl remarked that “the problem of matter is still shrouded in the deepest gloom” [65], and classical physics never became any better.

4. Don't waste time on "numerology"

A popularly held belief is that the dimensionless parameters of nature will turn out to be computable from first principles. For instance, Eddington spent years of his life developing theories where α was exactly $1/136$ and exactly $1/137$, respectively. If the above-mentioned analysis of heavy element production in stars were to reveal that the archipelago of habitability covered only a tiny fraction of the parameter space in Figure 5, then within the framework of our TOE, we would conclude that it is highly unlikely that α is given by "numerology", and concentrate our research efforts elsewhere.

5. Shun classical prejudice

Since all mathematical structures have PE in this theory, it of course allows no sympathy whatsoever for subjective nostalgic bias towards structures that resemble cozy classical concepts. For instance, criticism of the Everett interpretation of quantum mechanics for being "too crazy" falls into this forbidden category. Similarly, a model clearly cannot be criticized for involving "unnecessarily large" ensembles.

6. Don't neglect the frog perspective

Considering how difficult it is to predict how a mathematical structure will be perceived by a SAS, a systematic study of this issue probably merits more attention than it is currently receiving. In the current era of specialization, where it is easy to get engrossed in mathematical technicalities, substantial efforts in phenomenology are needed to make the connection with observation, going well beyond simply computing cross sections and decay rates.

H. Outlook

Even if we are eventually able to figure out which mathematical structure we inhabit, which in the terminology of Weinberg [8] corresponds to discovering "the final theory" (note that our usage of 'the word "theory" is slightly different), our task as physicists is far from over. In Weinberg's own words [8]: "*Wonderful phenomena, from turbulence to thought, will still need exploration whatever final theory is discovered. The discovery of a final theory will not necessarily even help very much in making progress in understanding these phenomena [...]. A final theory will be final in only one sense — it will bring to an end a certain sort of science, the ancient search for those principles that cannot be explained in terms of deeper principles.*"

If the TOE proposed in this paper is indeed correct, then the search for the ultimate principles has ended in a slight anti-climax: finding the TOE was easy, but working out its experimental implications is probably difficult enough to keep physicists and mathematicians occupied for generations to come.

ACKNOWLEDGMENTS

The author wishes to thank Andreas Albrecht, Mark Alford, John Barrow, Mats Boij, Martin Bucher, Ted Bunn, Angélica de Oliveira-Costa, Freeman Dyson, Piet Hut, Brit Katzen, Andrei Linde, Dieter Maison, David Pittuck, Rainer Plaga, Bill Poirier, Georg Raffelt, Svend Rugh, Derek Storkey, Frank Tipler, John A. Wheeler, Frank Wilczek and especially Harold Shapiro for stimulating discussions on some of the above-mentioned topics.

-
- [1] S. Coleman, Nucl. Phys. B, **307**, 867 (1988).
 - [2] A. D. Linde & M. I. Zelnikov, Phys. Lett. B, **215**, 59 (1988).
 - [3] A. D. Linde, *Particle Physics and Inflationary Cosmology* (Harwood, Chur, Switzerland, 1990) p306, p318.
 - [4] A. Vilenkin, Phys. Rev. Lett., **74**, 846 (1995)
A. Vilenkin, preprint gr-qc/9507018.
A. Vilenkin, Phys. Rev. D, **52**, 3365 (1995).
A. Vilenkin, preprint gr-qc/9512031.
A. Vilenkin & S. Winitzki, S, Phys. Rev. D, **55**, 548.
 - [5] A. Albrecht, in *The Birth of the Universe and Fundamental Forces*, ed. F. Occionero (Springer, Berlin, 1994), gr-qc/9408023.
 - [6] J. A. Wheeler, *At Home in the Universe* (AIP, New York, 1994).
 - [7] R. Nozick, *Philosophical Explanations* (Harvard Univ. Press, Cambridge, 1981).
 - [8] S. Weinberg, *Dreams of a Final Theory* (Pantheon, New York, 1992), p18, p238.
 - [9] R. Rucker *Infinity and the Mind* (Birkhauser, Boston, 1982).
 - [10] P. Davies *The Mind of God* (Touchstone, New York, 1993); D. Sciama, in *The Anthropic Principle*, Bertoli & Curi, Eds. (Cambridge Univ. Press, Cambridge, 1993), pp. 107-109.
 - [11] J. D. Barrow *Theories of Everything* (Ballantine, New York, 1991).
 - [12] J. D. Barrow *Pi in the Sky* (Clarendon, Oxford, 1992).
 - [13] S. Weinberg, Phys. Rev. Lett., **59**, 2607 (1987).
G. Efstathiou, MNRAS, **274**, L73
H. Martel, P. R. Shapiro & S. Weinberg, ApJ, **492**, 29 (1998).
M. Tegmark & M. J. Rees, ApJ **499**, 526 (1998).
 - [14] F. Dyson, Sci. Am. **225**, 50 (Sept. 1971).

- [15] B. Carter, in *IAU Symposium 63*, Ed. S. Longair (Reidel, Dordrecht, 1974).
- [16] P. C. W. Davies, *The Accidental Universe* (Cambridge U. P., Cambridge, 1982).
- [17] J. D. Barrow & F. J. Tipler, *The Anthropic Cosmological Principle* (Clarendon Press, Oxford, 1986).
- [18] Y. V. Balashov, *Am. J. Phys.* **59**, 1069 (1991).
- [19] D. Hilbert & P. Bernays, *Grundlagen der Mathematik* (Springer, Berlin, 1934).
- [20] R. L. Goodstein, *Boolean Algebra* (Leicester Univ. Press, Leicester, 1963).
R. L. Goodstein, *Mathematical Logic* (Leicester Univ. Press, Leicester, 1965).
D. R. Hofstadter, *Gödel, Escher, Bach: an Eternal Golden Braid* (Basic Books, New York, 1979).
- [21] F. J. Tipler, *The Physics of Immortality* (Doubleday, New York, 1994), p210.
- [22] A. Robinson, *Introduction to model theory and to the metamathematics of Algebra* (North-Holland, Amsterdam, 1962).
- [23] H. Doughty, unpublished preprint (1989).
- [24] H. S. Shapiro, private communication (1996).
- [25] H. Everett III, *Rev. Mod. Phys.* **29**, 454 (1957).
H. Everett III, *The Many-Worlds Interpretation of Quantum Mechanics*, B. S. DeWitt and N. Graham, eds. (Princeton U. P., Princeton, 1986).
J. A. Wheeler, *Rev. Mod. Phys.* **29**, 463 (1957).
L. M. Cooper & D. van Vechten, *Am. J. Phys.* **37**, 1212 (1969).
B. S. DeWitt, *Phys. Today* **23**, 30 (1971).
- [26] H. D. Zeh, *Found. Phys.* **1**, 69 (1970).
W. H. Zurek, *Phys. Rev. D* **24**, 1516 (1981).
W. H. Zurek, *Phys. Rev. D* **26**, 1862 (1982).
W. H. Zurek, *Phys. Today* **44** (10), 36 (1991).
E. Joos and H. D. Zeh, *Z. Phys. B* **59**, 223 (1985).
M. Tegmark, *Found. Phys. Lett.* **6**, 571 (1993).
- [27] C. J. Isham, in proceedings of 1991 Schladming Winder School.
- [28] A. Eddington, *Space, Time & Gravitation* (Cambridge U. P., Cambridge, 1920).
- [29] D. Deutsch *The fabric of reality* (Allen Lane, New York, 1997).
- [30] M. Tegmark, quant-ph/9709032, in *Fundamental Problems in Quantum Theory*, eds. M. H. Rubin & Y. H. Shih, *Fortschr. Phys.*, in press (1998).
- [31] B. Carr & M. J. Rees, *Nature* **278**, 605 (1979).
- [32] W. H. Press & A. P. Lightman, *Philos. Trans. R. Soc. London A* **310**, 323 (1983).
- [33] P. C. W. Davies, *J. Phys. A* **5**, 1296 (1972).
- [34] F. Hoyle, D. N. F. Dunbar, W. A. Wenzel & W. Whaling, *Phys. Rev.* **92**, 1095 (1953).
- [35] E. Schrödinger, *What is Life?* (Cambridge U. P., Cambridge, 1947).
- [36] M. Tegmark, *Classical & Quantum Gravity*, **14**, L69 (1997).
- [37] P. Ehrenfest, *Proc. Amsterdam Acad.* **20**, 200 (1917).
- [38] P. Ehrenfest, *Ann. Physik* **61**, 440 (1920).
- [39] W. Büchel, *Physikalische Blätter* **19**, 547 (1963).
- [40] I. M. Freeman, *Am. J. Phys.* **37**, 1222 (1969).
- [41] F. R. Tangherlini, *Nuovo Cim.* **27**, 636 (1963).
- [42] H. Poincaré, *Dernières pensées* (Flammarion, Paris, 1917).
- [43] R. Courant & D. Hilbert, *Methods of Mathematical Physics* (Interscience, New York, 1962).
- [44] H. B. Nielsen & S. E. Rugh, hep-th/9407011, in *Wendisch-Rietz meeting*, eds. B. Dörfel and W. Wic-zorek (DESY, Hamburg, 1995).
- [45] G. J. Whitrow, *Br. J. Phil.* **6**, 13 (1955).
- [46] C. W. Misner, K. S. Thorne, & J. A. Wheeler, *Gravitation* (Freeman, San Francisco, 1973), page 1205.
- [47] S. Deser, R. Jackiw & G. T'Hooft, *Ann. Physics* **152**, 220 (1984).
- [48] J. Barrow, *Phil. Trans. Roy. Soc. A*, **310**, 337 (1983)
J. Barrow, *Origin of the Universe* (Basic Books, London, 1994), p130.
- [49] J. Dorling, *Am. J. Phys.* **38**, 539 (1969).
- [50] L. Asgeirsson, *Math. Ann.* **113**, 321 (1936).
- [51] E. Witten, private communication (1996).
- [52] G. Feinberg, *Phys. Rev.* **159**, 1089 (1967).
- [53] S. W. Hawking, *Nucl. Phys. B* **244**, 135 (1984). C. J. Isham, *Class. Quantum Grav.* **6**, 1509 (1989).
- [54] J. A. Wheeler, in *Foundational problems in the special sciences* (Reidel, Dordrecht, 1977).
- [55] H. B. Nielsen, *Phil. Trans. Royal Soc. London*, **A310**, 261 (1983).
C. D. Froggatt & H. B. Nielsen, *Origin of Symmetries*, (World Scientific, 1991)
H. B. Nielsen, S. E. Rugh & C. Surlykke, hep-th/9407012 (1994).
- [56] M. Tegmark, *Found. Phys. Lett.* **9**, 25 (1996).
- [57] R. J. Solomonoff, *Inf. Control* **7**, 1 (1964).
- [58] G. J. Chaitin, *Algorithmic Information Theory*, (Cambridge U. P., Cambridge, 1987).
- [59] W. H. Zurek, *Nature* **341**, 119 (1989).
- [60] E. P. Wigner, *Symmetries and Reflections* (MIT Press, Cambridge, 1967).
- [61] H. B. Curry, *Outlines of a formalist philosophy of mathematics* (North Holland, Amsterdam, 1951).
- [62] G. Greenstein & A. Kropf, *Am. J. Phys.* **57**, 746 (1989).
- [63] S. Hawking *A Brief History of Time* (Touchstone, New York, 1993), p174.
- [64] R. Penrose, *The Emperor's New Mind* (Oxford Univ. Press, 1989).
- [65] H. Weyl, *Space, Time, Matter*, (Methuen, London, 1922).