



Présentation CFE-CGC ALCATTEL CIT

Bertrand LAPRAYE

▶ BROADEN YOUR LIFE ▶

LA CFE-CGC ALCATEL CIT Début 2005



- > **8 établissements**
- > EU 480 salariés Usine de production (Seine Maritime)
- > LANNION 950 salariés centre de R&D et installation export (Cotes d'Armor)
- > MARCOUSSIS 360 salariés centre de R&D (Essonne)
- > MASSY 600 salariés centre de R&D et SSII (Essonne)
- > ORMES 450 salariés centre installation domestique et service (Loiret)
- > ORVAULT 590 salariés centre de R&D et support (Loire Atlantique)
- > VELIZY 2600 salariés siège et centre de R&D (Yvelines)
- > VILLARCEAUX 400 salariés centre de R&D (Essonne)

ALCATEL CIT CCE composition

> La composition du CCE ALCATEL CIT

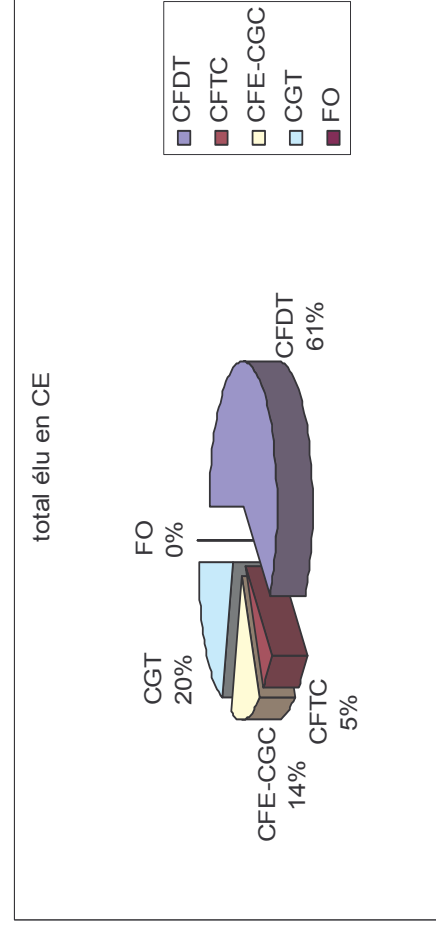
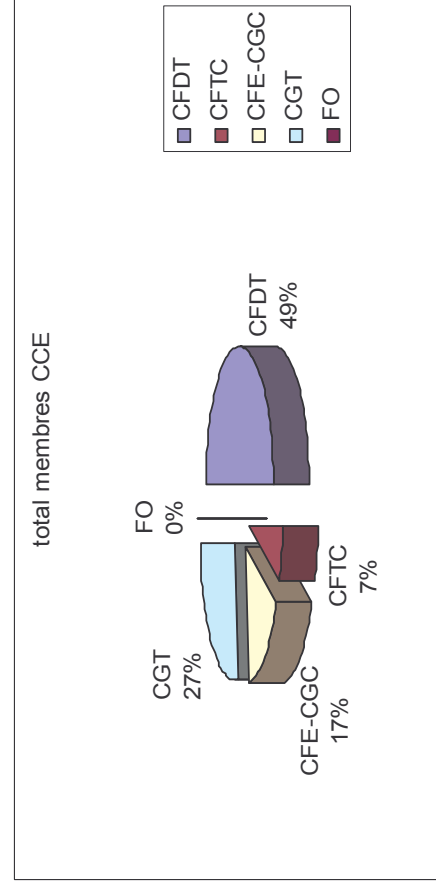
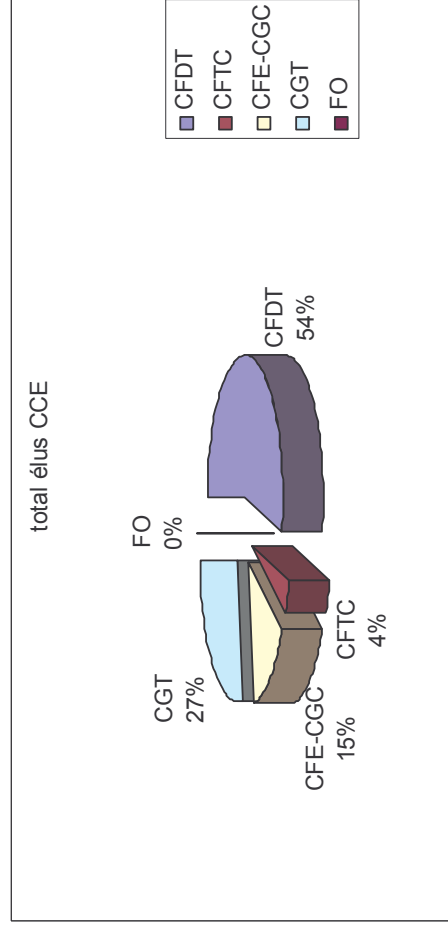
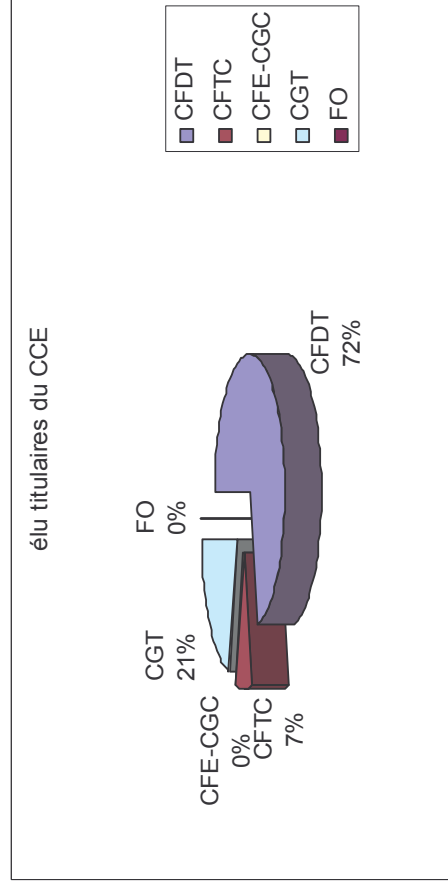

LA CFE-CGC à ALCATEL CIT



DOMINIONS DE LA FORCE
A VOS COMPÉTENCES

Etablissement	DS	Elu CE 3 ^{ème} collège	Elu 2 ^{ème} collège	Cartes	% 3 ^{ème} collège	% Total salariés
EU	1	1	0	2	58 %	7,4 %
LANNION	3	1	0	18	16 %	12,8 %
MARCOUSSIS	2	2	0	8	46 %	45 %
MASSY	1	0	0	1	0 %	0 %
ORMES	1	1	0	14	44 %	17 %
ORVAULT	2	0	0	7	11,5 %	9,4 %
VELIZY	3	2	0	21	25 %	20 %
VILLARCEAUX	1	1	0	5	28 %	25 %

Vélizy global participation 56 %

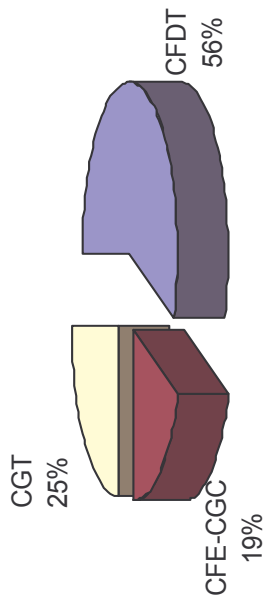

Vélizy 3^{ème} collége

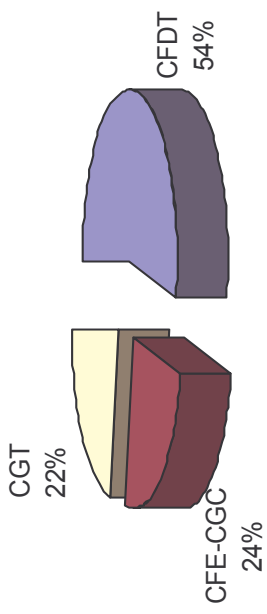

VILLARCEAUX Novembre 2004



DOMINONS DE LA FORCE
A VOS COMPETENCES

Villarceaux global participation 58 %

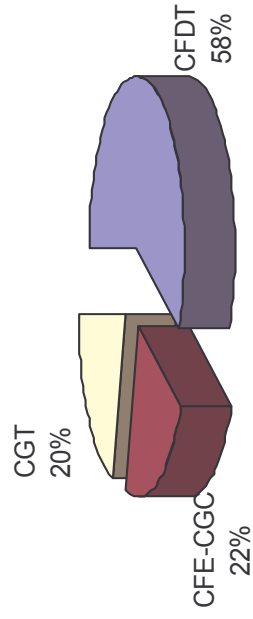

Villarceaux 3ème Collège

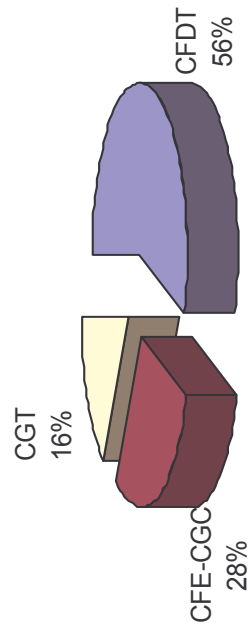

1er et 2ème Collège EU

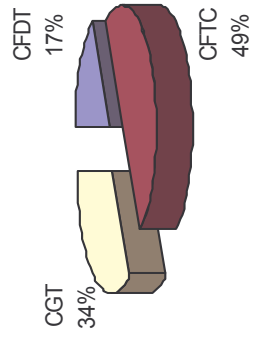

EU global participation 67 %

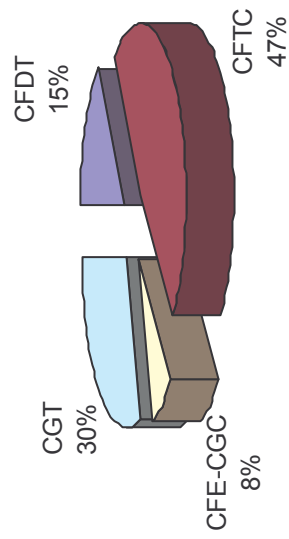

3ème collège EU

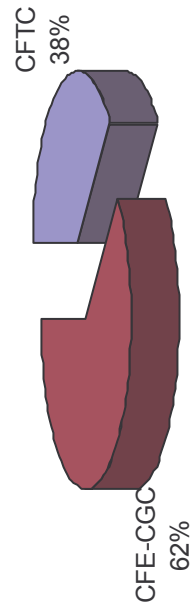

ORVAULT Avril 2004



DOMINONS DE LA FORCE
A VOS COMPETENCES

Orvault global participation 82 %

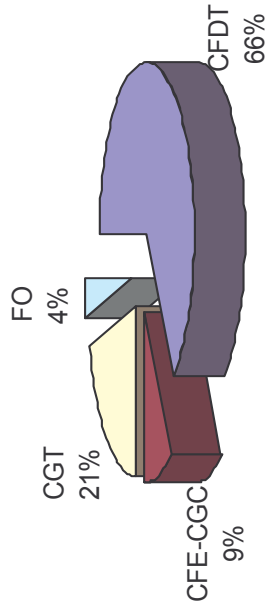

3^{ème} collège Orvault

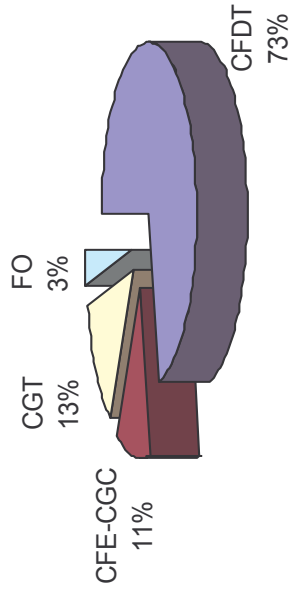

MASSY Mars 2005



DOMINONS DE LA FORCE
A VOS COMPETENCES

MASSY global participation 63 %

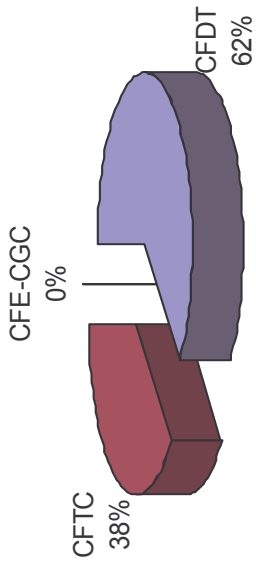

3ème collège Massy

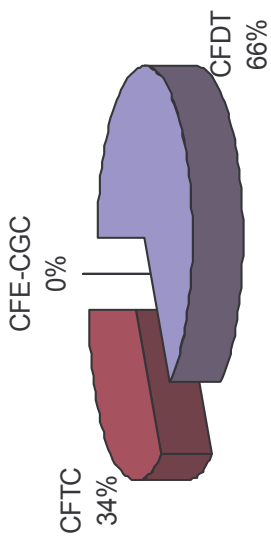

ORMES Mars 2005



DOMINONS DE LA FORCE
A VOS COMPETENCES

Ormes global participation 69 %

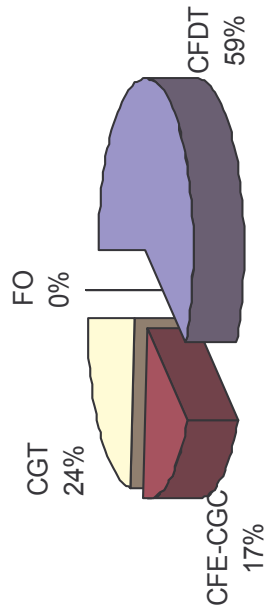

3^{ème} collège Ormes

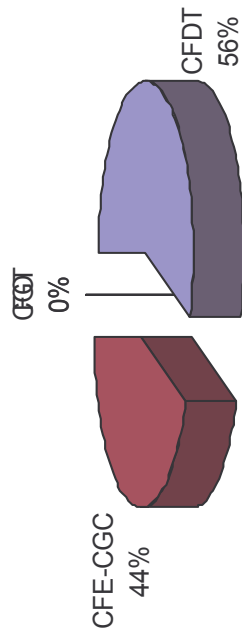

LANNION Avril 2004



DOMINONS DE LA FORCE
A VOS COMPETENCES

Lannion global participation 75 %

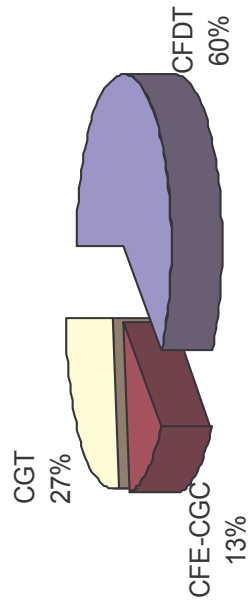

Lannion 3ème collège

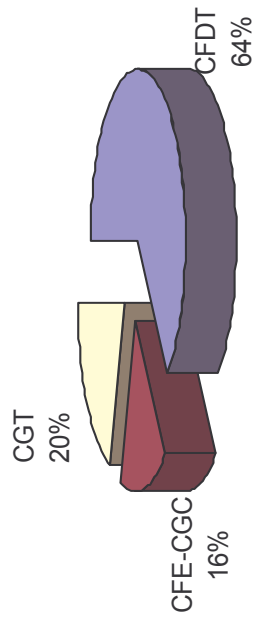

MARCOUSSIS Avril 2004



DOMINONS DE LA FORCE
A VOS COMPETENCES

MARCOUSSIS global participation 67 %

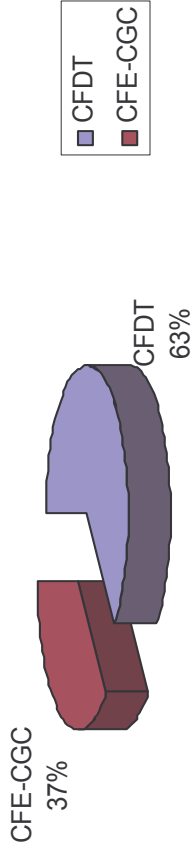

MARCOUSSIS 3ème collège



Global ALCATEL CIT

GLOBAL ALCATEL CIT participation 65 %



DOMINONS DE LA FORCE
A VOS COMPETENCES

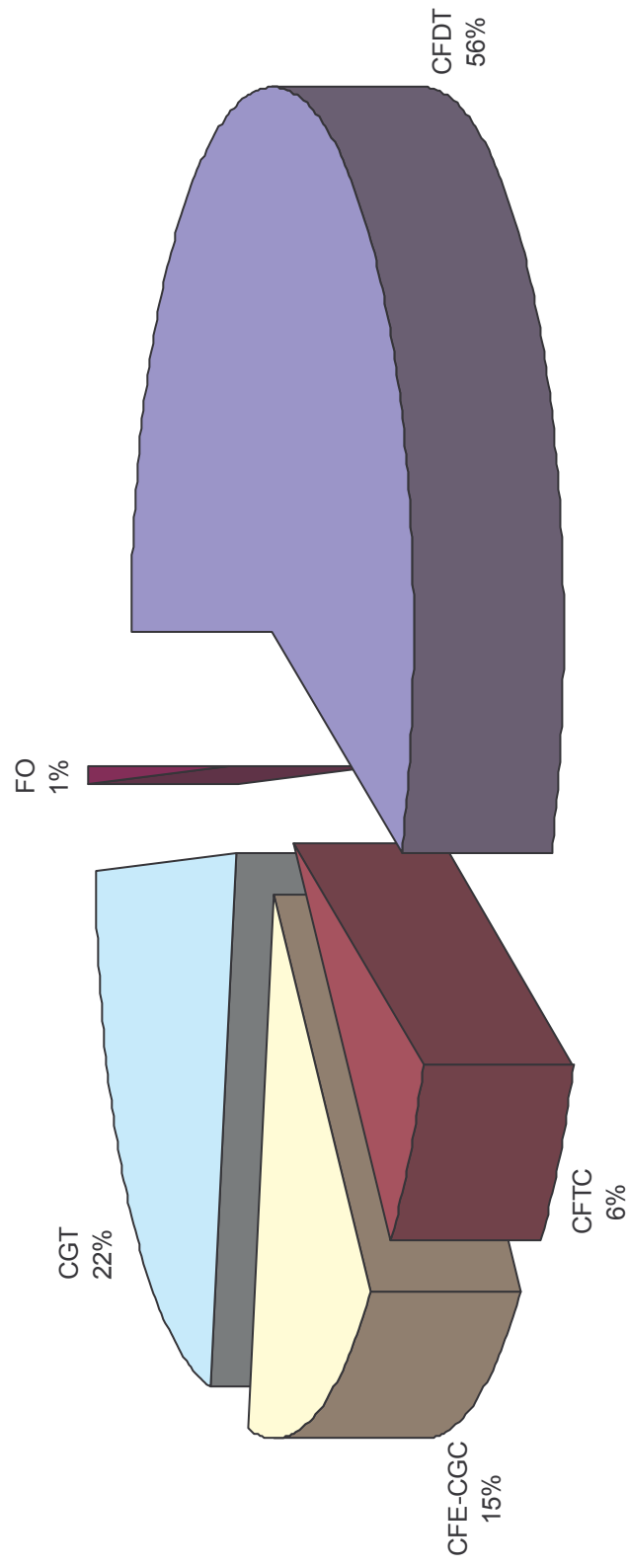

Global ALCATEL CIT

3ème collège ALCATEL CIT



DOMINONS DE LA FORCE
A VOS COMPÉTENCES

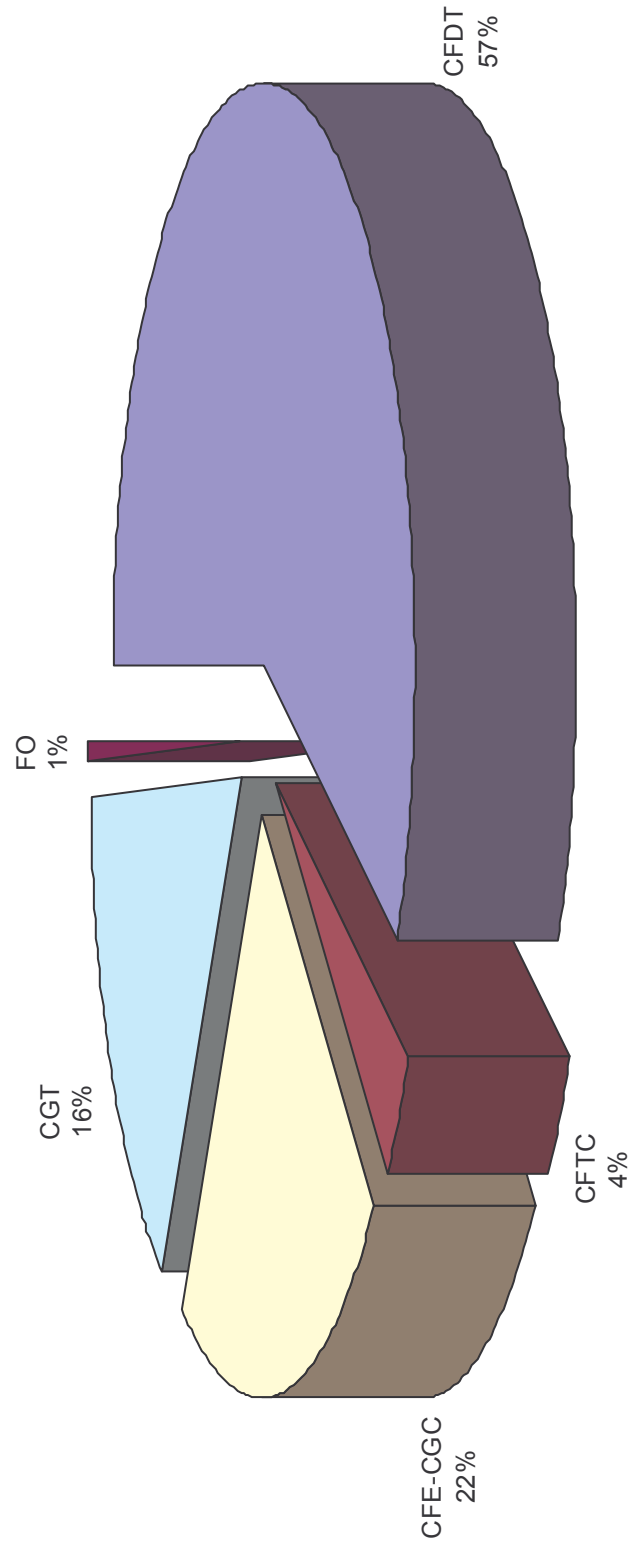

www.alcatel.com

ARCHITECTS OF AN INTERNET WORLD

